

Made in ITALY

12



UTENSILI  
PER FRESATURA  
MILLING TOOLS



12

	pagina page	
Inserti per fresatura Milling Inserts	3 ÷ 9	
Utensili per fresatura Milling Tools	11 ÷ 17	

## INDICE

	pag. page
<b>INSERTI PER FRESATURA / MILLING INSERTS</b>	
Chiave di lettura degli inserti per fresatura / Milling inserts code key	4-5
Rivestimento, raccomandazioni d'uso / Grades overview, advice for use	5
Inserti per fresatura 45° / 45° Milling inserts SEKT	6
Inserti per fresatura 90° / 90° Milling inserts APKT	7
Inserti per fresatura 3D / 3D Milling inserts RDKW	8-9
<b>UTENSILI PER FRESATURA / MILLING TOOLS</b>	
Chiave di lettura degli utensili per fresatura / Milling tools code key	12-13
Testine per fresature / Exchangeable heads for milling TORICHE / TORIC TYPE	14
Frese per spallamenti 90° / Shoulder milling cutters 90° L90 AP10	14-15
L90 AP16	15-16
Frese per spianature 45° / Face milling cutters 45° L45 SE12	16
Frese toriche per spianature e copiature / Toric milling cutters for copyng & facing L00 RD12T	17
L00 RD16	17





**INSERTI**  
**per FRESATURA**

**MILLING**  
**INSERTS**



## LEGENDA / KEY

CODE	Forma Form
------	---------------

<b>S</b>	A spigolo Square 
<b>A</b>	Parallelogramma 85° Parallelogramm 85° 
<b>R</b>	Rotondo Round 

CODE	Tolleranza altezza punta M Tolerance M - class (mm)	Tolleranza del cerchio inscritto IC Tolerance incircle IC (mm)	Tolleranza S Tolerance S (mm)
<b>K</b>	± 0.013	± 0.05 – ± 0.15	± 0.025

**1** Forma inserto  
Insert form



**3** Classe di tolleranza / Tolerances

**A P K T**



**2** Angolo di spoglia  
Clearance angle

**4** Tipo di inserto / Insert type

CODE	Angolo Angle
------	-----------------

<b>D</b>	15° 
<b>E</b>	20° 
<b>P</b>	11° 

Metrico / Metric				
CODE	Foro Hole	Configurazione foro Hole configuration	Rompi trucioli Chip breaker	Figura Insert shape

<b>W</b>	con foro with hole	cilindrica + svasatura (40–60°) cylindrical hole + reduction single side (40–60°)	NO	
<b>T</b>	con foro with hole	cilindrica + svasatura (40–60°) cylindrical hole + reduction single side (40–60°)	unilaterale single side	

## PANORAMICA OVERVIEW

Geometria Grade	ISO	Intervallo di elaborazione Application range										Gruppi di materiale Material group			
		01	05	10	15	20	25	30	35	40	45	50	<b>P</b> Acciaio / Steel		
<b>P25M</b>	HC-P25														•
<b>P35M</b>	HC-P35														•

Picco di applicazione  
Application peak



Gamma completa per ISO 513  
Full range to ISO 513

## LEGENDA / KEY

Simbolo / Insert shape			
S	A	R	Ø del cerchio inserito Incircle diameter (mm)
		07	7.00
	10	10	10.00
		12	12.00
12			12.70
	16	16	16.00

CODE	Spessore Thickness (mm)
02	2.38
03	3.18
T3	3.97
04	4.76

**5** Lunghezza di taglio / Cutting edge length

**6** Spessore dell'inserto / Insert thickness

**5** **10** **6** **03** **7** **PD**

<b>7</b> Codice rompitruciolo / Chipbreaker code	
Direzione di taglio / Cutting direction	
Code	Direzione di taglio Cutting direction
R	Destra / Right
L	Sinistra / Left
N	Neutro / Neutral
Condizioni di taglio / Cutting edge	
Code	Forma / Shape
S	Spigolo arrotondato e smussato Chamfered and rounded

## RIVESTIMENTO - RACCOMANDAZIONI D'USO GRADES OVERVIEW - APPLICATION RECOMMENDATION

### P25M

Rivestito in PVD (carburo rivestito) particolarmente adatto per elevate velocità di taglio su lavorazioni a secco e a umido in condizioni stabili.

Grado multiuso per la fresatura di acciaio legati ed inossidabili.

Multi purpose grade for milling unalloyed, low alloyed, high alloyed and stainless steel. The PVD coated grade is especially suitable for high cutting speeds on dry / wet machining under stable conditions.

### P35M

Rivestito in PVD (carburo rivestito) per fresatura universale dell'acciaio in combinazione con un angolo di avvicinamento di 90°. Particolarmente adatto per la fresatura a secco a velocità di taglio medio-basse in condizioni difficili.

Universal steel milling grade in combination with 90° approach angle. A PVD layer and a tough carbide grade for milling of the most usual steel qualities. Especially good suitable for dry milling at low to medium cutting speeds under difficult conditions.

## AVANZAMENTI (FORMULE) / FEED (FORMULAS)

N° giri mandrino Spindle speed	Velocità di taglio Cutting speed	$v_c$ Velocità di taglio Cutting speed
$n$ ( $\text{min}^{-1}$ ): $n = \frac{v_c \cdot 1000}{\pi \cdot d_1}$	$v_c$ (m/min): $v_c = \frac{n \cdot \pi \cdot d_1}{1000}$	$n$ N° giri mandrino Spindle speed
Velocità di avanzamento Feed rate	Avanzamento per dente Feed per tooth	$d_1$ Ø di taglio cutter Ø
$V_f$ (mm/min): $V_f = f_z \cdot z \cdot n$	$f_z$ (mm): $f_z = \frac{V_f}{z \cdot n}$	$v_f$ Velocità di avanzamento Feed rate
		$f_z$ Avanzamento per dente Feed per tooth
		$z$ N° di denti Number of teeth

## INSERTI PER FRESATURA 45° / 45° MILLING INSERTS

### SE.. 12..

Geometria inserto Insert geometry	Profondità di taglio Cutting depth (mm) $a_p$ max	Avanzamenti Feed (mm) $f_z$
LP	1 4 6	0,16 <b>0,25</b> 0,35

### RACCOMANDAZIONI SULLA VELOCITÀ DI TAGLIO PER FRESATURA A 45° CUTTING SPEED RECOMMENDATIONS FOR MILLING CUTTER 45°

Materiale Material	Lavorazione a secco Dry machining	Vc m/min	
		P25M	P35M
<b>P</b> Acciaio strutturale Structural steel	•	190-290	150-230
Acciaio trattato termicamente Heat treated steel	•	160-230	130-180
Acciaio per utensili Tool steel	•	145-210	110-160
Acciaio trattato termicamente (alta resistenza) Heat treated steel (high strength)	•	110-170	

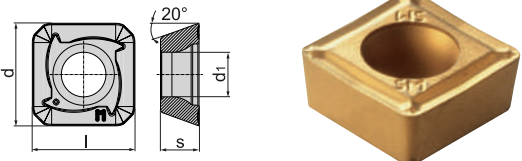
ART.	l	d	s	$d_1$	Rivestimento Coated	
					<b>P</b>	
					P25M	P35M
<b>SEKT1204AFSN-LP-P25M</b>	12,70	12,70	4,76	5,5	•	

## AVANZAMENTI (FORMULE) / FEED (FORMULAS)

N° giri mandrino Spindle speed	Velocità di taglio Cutting speed	$V_c$ Velocità di taglio Cutting speed
$n$ (min <sup>-1</sup> ): $n = \frac{V_c \cdot 1000}{\pi \cdot d_1}$	$v_c$ (m/min): $v_c = \frac{n \cdot \pi \cdot d_1}{1000}$	$n$ N° giri mandrino Spindle speed
Velocità di avanzamento Feed rate	Avanzamento per dente Feed per tooth	$d_1$ Ø di taglio cutter Ø
$V_f$ (mm/min): $V_f = f_z \cdot z \cdot n$	$f_z$ (mm): $f_z = \frac{V_f}{z \cdot n}$	$V_f$ Velocità di avanzamento Feed rate
		$f_z$ Avanzamento per dente Feed per tooth
		$z$ N° di denti Number of teeth

## INSERTI PER FRESATURA 90° / 90° MILLING INSERTS

### APT 10..

Geometria inserto Insert geometry	Profondità di taglio Cutting depth (mm) $a_p$ max	Avanzamenti Feed (mm) $f_z$
LP2	0,5 <b>3</b> 9	0,1 <b>0,15</b> 0,2

### APT 16..

Geometria inserto Insert geometry	Profondità di taglio Cutting depth (mm) $a_p$ max	Avanzamenti Feed (mm) $f_z$
LP2	1 <b>8</b> 15	0,1 <b>0,15</b> 0,2

## RACCOMANDAZIONI SULLA VELOCITÀ DI TAGLIO PER FRESATURA A 90° CUTTING SPEED RECOMMENDATIONS FOR MILLING CUTTER 90°

	Materiale Material	Lavorazione a secco Dry machining	$V_c$ m/min	
			P25M	P35M
<b>P</b>	Acciaio strutturale Structural steel	•	190-290	150-230
	Acciaio trattato termicamente Heat treated steel	•	160-230	130-180
	Acciaio per utensili Tool steel	•	145-210	110-160
	Acciaio trattato termicamente (alta resistenza) Heat treated steel (high strength)	•	110-170	

ART.	l	d	s	$d_1$	r	Rivestimento Coated	
						<b>P</b>	
						P25M	P35M
APKT1003PDSR-LP-P35M	10	6,7	3,5	2,8	0,5		•
APKT1604PDSR-LP-P35M	16	9,52	5,26	4,5	0,8		•



## AVANZAMENTI (FORMULE) / FEED (FORMULAS)

N° giri mandrino Spindle speed	Velocità di taglio Cutting speed	$v_c$ Velocità di taglio Cutting speed
$n$ (min <sup>-1</sup> ): $n = \frac{v_c \cdot 1000}{\pi \cdot d_1}$	$v_c$ (m/min): $v_c = \frac{n \cdot \pi \cdot d_1}{1000}$	$n$ N° giri mandrino Spindle speed
Velocità di avanzamento Feed rate	Avanzamento per dente Feed per tooth	$d_1$ Ø di taglio cutter Ø
$V_f$ (mm/min): $V_f = f_z \cdot z \cdot n$	$f_z$ (mm): $f_z = \frac{V_f}{z \cdot n}$	$v_f$ Velocità di avanzamento Feed rate
		$f_z$ Avanzamento per dente Feed per tooth
		$z$ N° di denti Number of teeth

## INSERTI PER FRESATURA 3D / 3D MILLING INSERTS

### RD.. 0702..

Geometria inserto Insert geometry	Profondità di taglio Cutting depth (mm) $a_p$ max	Avanzamenti Feed (mm) $f_z$
LP	0,25 <b>1</b> 1,7	0,14 <b>0,27</b> 0,6

### RD.. 1003..

Geometria inserto Insert geometry	Profondità di taglio Cutting depth (mm) $a_p$ max	Avanzamenti Feed (mm) $f_z$
LP	0,28 <b>1,5</b> 2,5	0,15 <b>0,28</b> 0,64

### RD.. 12T3..

Geometria inserto Insert geometry	Profondità di taglio Cutting depth (mm) $a_p$ max	Avanzamenti Feed (mm) $f_z$
LP	0,3 <b>1,8</b> 3	0,16 <b>0,29</b> 0,7

### RD.. 1604..

Geometria inserto Insert geometry	Profondità di taglio Cutting depth (mm) $a_p$ max	Avanzamenti Feed (mm) $f_z$
LP	0,3 <b>2,4</b> 4	0,18 <b>0,3</b> 0,75



### RACCOMANDAZIONI SULLA VELOCITÀ DI TAGLIO PER FRESATURA 3D CUTTING SPEED RECOMMENDATIONS FOR 3D MILLING CUTTER

	Materiale Material	Lavorazione a secco Dry machining	Vc m/min	
			P25M	P35M
<b>P</b>	Acciaio strutturale Structural steel	•	200-300	170-260
	Acciaio trattato termicamente Heat treated steel	•	180-280	150-240
	Acciaio per utensili Tool steel	•	160-250	140-220
	Acciaio trattato termicamente (alta resistenza) Heat treated steel (high strength)	•	130-180	

ART.	d	s	d <sub>1</sub>	Rivestimento Coated		
				P		
				P25M	P35M	
	<b>RDKW0702MOS-LP-P25M</b>	7	2,38	2,7	•	
	<b>RDKW1003MOS-LP-P25M</b>	10	3,18	3,9	•	
	<b>RDKW12T3MOS-LP-P25M</b>	12	3,97	3,9	•	
	<b>RDKW1604MOS-LP-P25M</b>	16	4,76	5,2	•	





**UTENSILI**  
**per FRESATURA**

**MILLING**  
**TOOLS**

**Made in ITALY**



**LEGENDA / KEY**

**SISTEMA DI CODIFICA FRESE STANDARD  
STANDARD MILLING CUTTERS CODIFICATION SYSTEM**

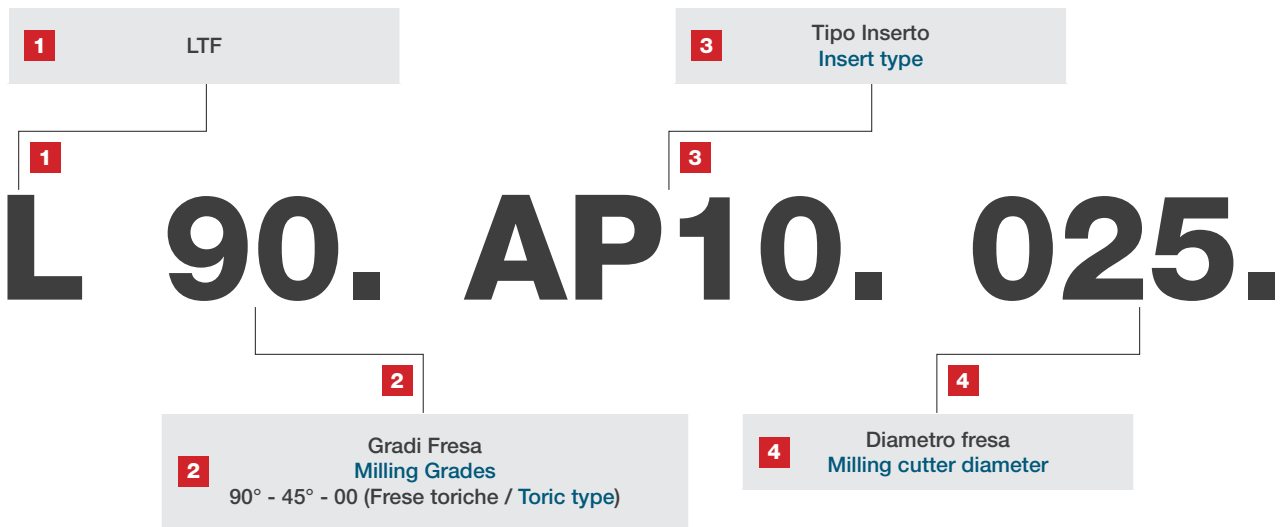
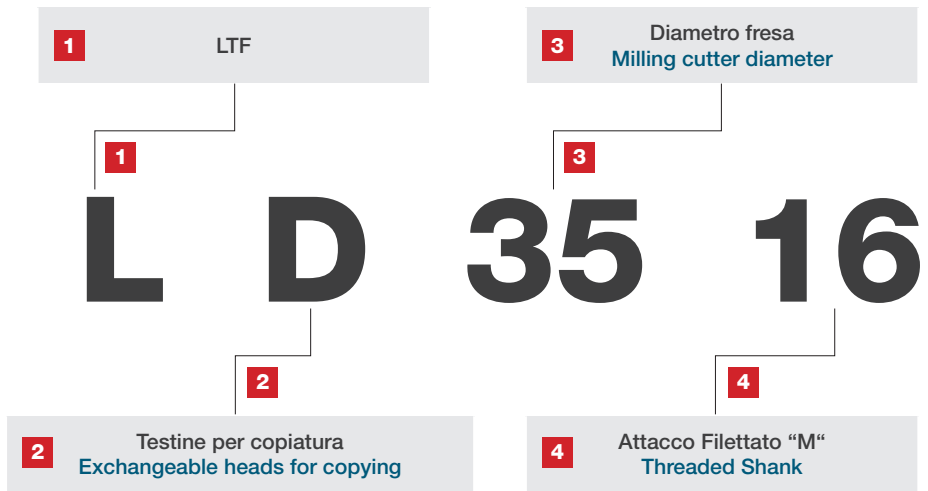



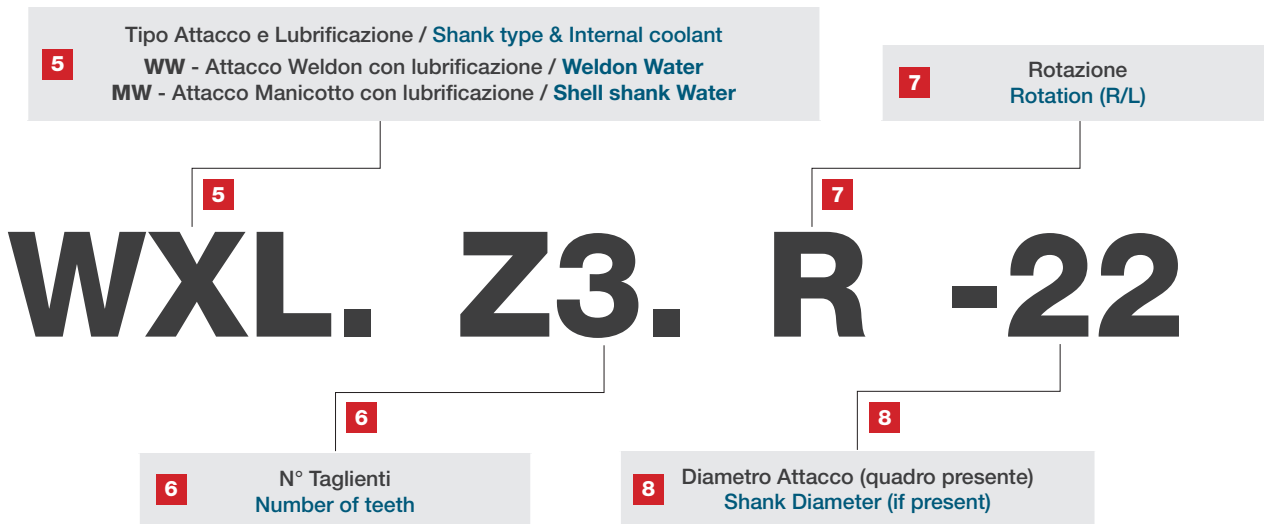
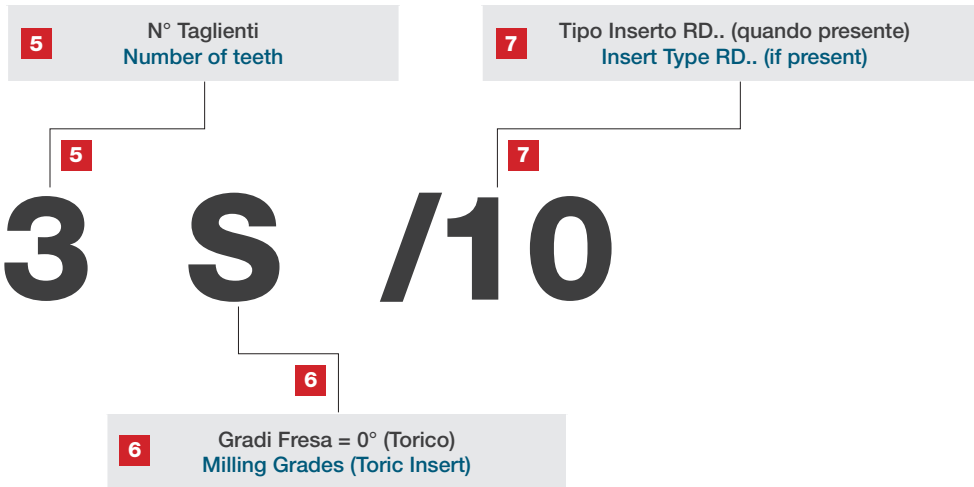





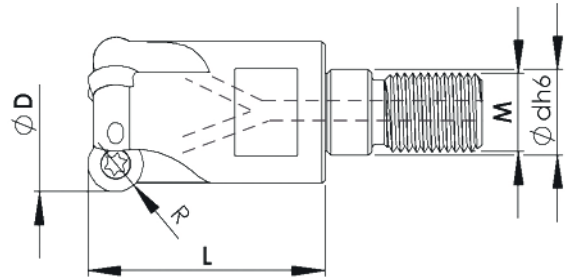

**LEGENDA / KEY**

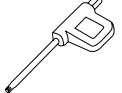

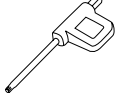
## UTENSILI PER FRESATURA / MILLING TOOLS

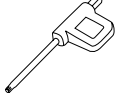

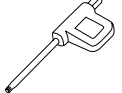

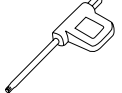



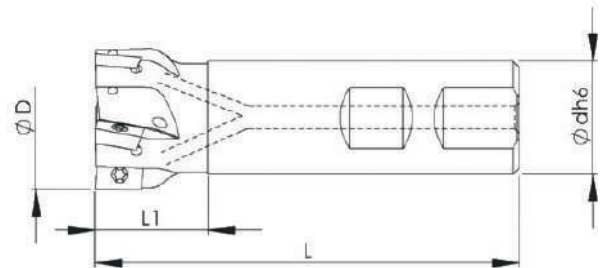

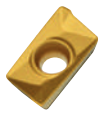
### TESTINE PER FRESATURE EXCHANGEABLE HEADS FOR MILLING

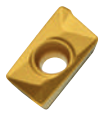

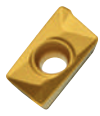
ART.	Attacco filettato / Threaded Shank						Inserti (non inclusi) Insert (not included)	Vite di fissaggio Fixing screw	Torx Key
	Ø D	L	M	Ø dh6	Z	R			
<b>LD1683S</b>	16	23	8	8,5	3	3,5			
<b>LD20104S</b>	20	30	10	10,5	4	3,5			
<b>LD20102S</b>	20	30	10	10,5	2	5			
<b>LD25123S</b>	25	35	12	12,5	3	5			
<b>LD35163S/10</b>	35	43	16	17	3	5			

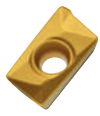
### FRESE PER SPALLAMENTI 90° SHOULDER MILLING CUTTERS 90°

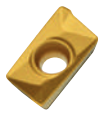



ART.	Serie normale attacco Weldon Standard Series Weldon Shank					Inserti (non inclusi) Insert (not included)	Vite Screw	Torx Key
	Ø D	L1	L	Ø dh6	Z			
<b>L90AP10012WWZ1R</b>	12	24	80	16	1			
<b>L90AP10016WWZ2R</b>	16	25	85	16	2			
<b>L90AP10020WWZ3R</b>	20	25	90	20	3			
<b>L90AP10025WWZ4R</b>	25	25	95	25	4			
<b>L90AP10032WWZ5R</b>	32	26	95	25	5			

## UTENSILI PER FRESATURA / MILLING TOOLS

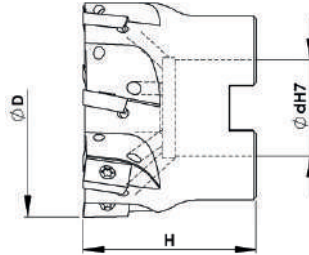

### FRESE PER SPALLAMENTI 90° SHOULDER MILLING CUTTERS 90°

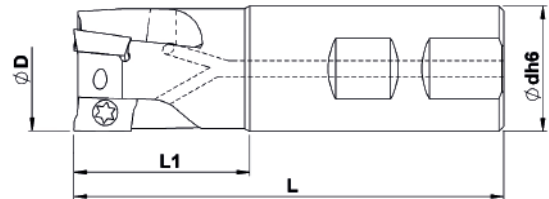

ART.	Attacco a manicotto Shell Shank				Inserti (non inclusi) Insert (not included)	Vite Screw	Torx Key
	Ø D	H	Ø dh7	Z			
L90AP10040MWZ6R-22	40	40	22	6			
L90AP10050MWZ5R	50	40	22	5	AP..1003	LVM2506	T08
L90AP10063MWZ6R	63	40	22	6	AP..1003	LVM2506	T08

### FRESE PER SPALLAMENTI 90° SHOULDER MILLING CUTTERS 90°

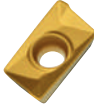

ART.	Serie normale attacco Weldon Standard Series Weldon Shank					Inserti (non inclusi) Insert (not included)	Vite Screw	Torx Key
	Ø D	L1	L	Ø dh6	Z			
L90AP16025WWZ2R	25	44	100	25	2			
L90AP16032WWZ3R	32	50	110	32	3	AP..1604	LVM4010	T15

## UTENSILI PER FRESATURA / MILLING TOOLS

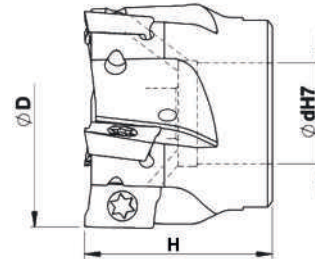

### FRESE PER SPALLAMENTI 90° SHOULDER MILLING CUTTERS 90°

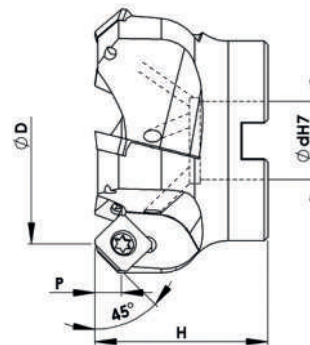

ART.	Attacco a manicotto Shell Shank				Inserti (non inclusi) Insert (not included)	Vite Screw	Torx Key
	Ø D	H	Ø dh7	Z			
L90AP16040MWZ4R	40	40	16	4			
L90AP16050MWZ5R	50	40	22	5	AP..1604	LVM4010	T15
L90AP16063MWZ5R	63	40	22	5	AP..1604	LVM4010	T15
L90AP16080MWZ6R	80	50	27	6	AP..1604	LVM4010	T15

### FRESE PER SPIANATURE 45° FACE MILLING CUTTERS 45°

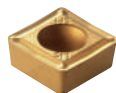

ART.	Attacco a manicotto Shell Shank					Inserti (non inclusi) Insert (not included)	Vite Screw	Torx Key
	Ø D	H	Ø dh7	P	Z			
L45SE12050MWZ4R	50	48	22	6	4			
L45SE12063MWZ5R	63	48	22	6	5	SE..1204	LVM5010	T20
L45SE12080MWZ6R	80	50	27	6	6	SE..1204	LVM5010	T20



## UTENSILI PER FRESATURA / MILLING TOOLS

### FRESE TORICHE PER SPIANATURE E COPIATURE TORIC MILLING CUTTERS FOR FACING AND COPYING

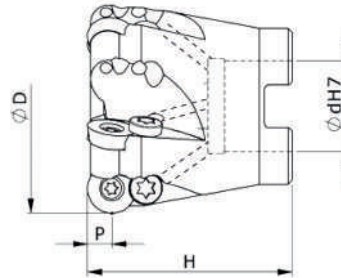

ART.	Attacco a manicotto Shell Shank					Inserti (non inclusi) Insert (not included)	Vite Screw	Vite di fissaggio Fixing screw	Torx Key
	Ø D	H	Ø dh7	P	Z				
L00RD12T3040MWZ4R	40	40	16	6	4				
L00RD12T3050MWZ5R	50	50	22	6	5				
L00RD12T3063MWZ6R	63	50	22	6	6				
L00RD12T3080MWZ7R	80	50	27	6	7				

### FRESE TORICHE PER SPIANATURE E COPIATURE TORIC MILLING CUTTERS FOR FACING AND COPYING

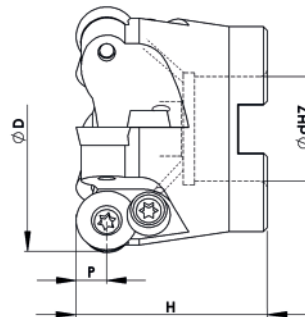

ART.	Attacco a manicotto Shell Shank					Inserti (non inclusi) Insert (not included)	Vite per inserto Screw for Insert	Rondella Lock Washer	Vite per rondella Screw Lock Washer	Torx Key
	Ø D	H	Ø dh7	P	Z					
L00RD16052MWZ4R	52	50	22	8	4					
L00RD16063MWZ5R	63	50	27	8	5					
L00RD16066MWZ5R	66	50	27	8	5					
L00RD16080MWZ6R	80	50	27	8	6					

