



**UTENSILI E CHIAVI A MANO
PROFESSIONALI
PROFESSIONAL
HAND TOOLS**



	pagina page	
<p>Bussole e cricchetti Sockets and ratchets</p>	<p>4 ÷ 11</p>	
<p>Chiavi Wrenches</p>	<p>12 ÷ 20</p>	
<p>Inserti Bits</p>	<p>21 ÷ 31</p>	
<p>Giraviti Screwdrivers</p>	<p>32 ÷ 40</p>	
<p>Pinze Pliers</p>	<p>41 ÷ 43</p>	
<p>Utensili per idraulica, morsetti e supporto estensibile Pipe tools, clamps and extensible supports</p>	<p>43 ÷ 47</p>	

	pagina page	
Utensili da taglio Cutting tools	47 ÷ 51	
Martelli ed asce Hammers and axes	52-53	
Rivettatrici Aggraffatrici Pistole per silicone Riveters Tackers Caulk guns	54-55	
Carrelli e banchi da lavoro Carts and workbenches	56-57	
Valigie portautensili Tool cases	58 ÷ 60	
Valigie portautensili vuote Empty tool cases	61-62	
Attrezzi magnetici e torce Magnetic tools and flashlights	62-63	

BUSOLE E CRICCHETTI SOCKETS AND RATCHETS

BUSOLE SUPERLOCK / SUPERLOCK SOCKETS

In Cromo Vanadio, attacco 1/4".

Made of Chrome Vanadium, 1/4" drive.

DATI TECNICI / TECHNICAL DATA

ART.	E07070	E07071	E07072	E07073	E07074
Misura / Size	mm 4	4,5	5	5,5	6
ART.	E07075	E07076	E07077	E07078	E07079
Misura / Size	mm 7	8	9	10	11
ART.	E07080	E07081	E07082		
Misura / Size	mm 12	13	14		



BUSOLE SUPERLOCK / SUPERLOCK SOCKETS

In Cromo Vanadio, attacco 3/8".

Made of Chrome Vanadium, 3/8" drive.

DATI TECNICI / TECHNICAL DATA

ART.	05980	05981	05982	05983	05984
Misura / Size	mm 6	7	8	9	10
ART.	05985	05986	05987	05988	05989
Misura / Size	mm 11	12	13	14	15
ART.	05990	05991	05992	05993	05994
Misura / Size	mm 16	17	18	19	20
ART.	05995	05996			
Misura / Size	mm 21	22			



BUSOLE SUPERLOCK / SUPERLOCK SOCKETS

In Cromo Vanadio, attacco 1/2".

Made of Chrome Vanadium, 1/2" drive.

DATI TECNICI / TECHNICAL DATA

ART.	05920	05921	05922	05923	05924
Misura / Size	mm 10	11	12	13	14
ART.	05925	05926	05927	05928	05929
Misura / Size	mm 15	16	17	18	19
ART.	05930	05931	05932	05933	05934
Misura / Size	mm 20	21	22	23	24
ART.	05935	05936	05937	05938	05939
Misura / Size	mm 25	26	27	28	30
ART.	05940				
Misura / Size	mm 32				



BUSOLE LUNGHE SUPERLOCK SUPERLOCK LONG SOCKETS

In Cromo Vanadio, attacco 1/2".

Made of Chrome Vanadium, 1/2" drive.

DATI TECNICI / TECHNICAL DATA

ART.	05945	05946	05947	05948
Misura / Size	mm 14	15	17	19



BUSSOLE E CRICCHETTI SOCKETS AND RATCHETS

BUSSOLE LUNGHE SUPERLOCK SUPERLOCK LONG SOCKETS

In Cromo Vanadio, attacco 1/4". Made of Chrome Vanadium, 1/4" drive.

DATI TECNICI / TECHNICAL DATA					
ART.	E07085	E07086	E07088	E07089	
Misura / Size	mm	6	7	9	10
ART.	E07090	E07091	E07092		
Misura / Size	mm	11	12	13	



BUSSOLE PER CANDELE GLOW PLUG SOCKETS

In Cromo Vanadio, attacco 1/2". Made of Chrome Vanadium, 1/2" drive.

DATI TECNICI / TECHNICAL DATA			
ART.	05943	05944	
Misura / Size	mm	16	21



SNODO UNIVERSALE / UNIVERSAL JOINT

In Cromo Vanadio. Made of Chrome Vanadium.

DATI TECNICI / TECHNICAL DATA			
ART.	E07024	05950	05951
Attacco / Drive	1/4"	3/8"	1/2"



PROLUNGA / EXTENSION

In Cromo Vanadio. Made of Chrome Vanadium.

DATI TECNICI / TECHNICAL DATA				
ART.	05952	05953	05954	05955
Attacco / Drive	3/8"	3/8"	1/2"	1/2"
Lunghezza / Length	mm	75	150	250
ART.	E07021	E07023		
Attacco / Drive	1/4"	1/4"		
Lunghezza / Length	mm	50	100	



PROLUNGA FLESSIBILE / FLEXIBLE EXTENSION BAR

In Cromo Vanadio. Made of Chrome Vanadium.

DATI TECNICI / TECHNICAL DATA		
ART.	E07026	
Attacco / Drive	1/4"	
Lunghezza / Length	mm	150

Confezione: supporto in plastica / Packaging: plastic support

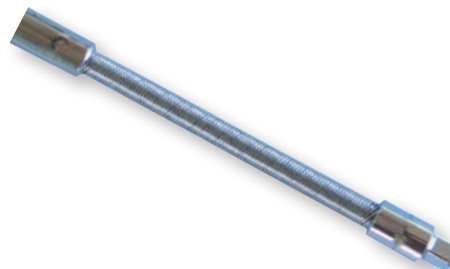

PROLUNGA ALLUNGABILE / ADJUSTABLE EXTENSION BAR

In Cromo Vanadio, testa snodata e bloccaggio di sicurezza. Made of Chrome Vanadium, with tilting head and safe locking.

DATI TECNICI / TECHNICAL DATA		
ART.	E06018	
Attacco / Drive	1/2"	
Lunghezza / Length	mm	296-448

Confezione: supporto in plastica / Packaging: plastic support

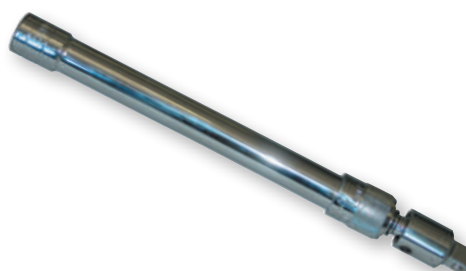

BUSSOLE E CRICCHETTI SOCKETS AND RATCHETS

ASTA DI MANOVRA SCORREVOLE / SLIDING T-HANDLE

In Cromo Vanadio.

Made of Chrome Vanadium.

DATI TECNICI / TECHNICAL DATA

ART.	E07095	E07096
Attacco / Drive	1/4"	1/2"

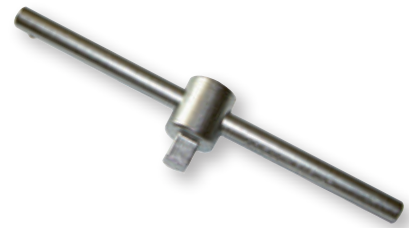

CHIAVE A CRICCHETTO / RATCHET

In Cromo Vanadio.

Made of Chrome Vanadium.

DATI TECNICI / TECHNICAL DATA

ART.	E06016	
Attacco / Drive	1/4"	
Bussole / Socket	mm	5-6-7-8-9-10-11-12-13
Inserti / Bits	taglio / slotted 6 mm PH1-2 / PZ1-2 Torx T10-15-20-25-30-40	

Confezione: doppio blister / Packaging: double blister



CRICCHETTO SNODABILE E ALLUNGABILE EXTENDABLE AND FLEXIBLE RATCHET

In Cromo Vanadio, con bloccaggio bussola e regolazione a 180°.

Made of Chrome Vanadium, with socket locking; head rotates 180°.

DATI TECNICI / TECHNICAL DATA

ART.	E07018	E07017
Attacco / Drive	1/4"	1/2"

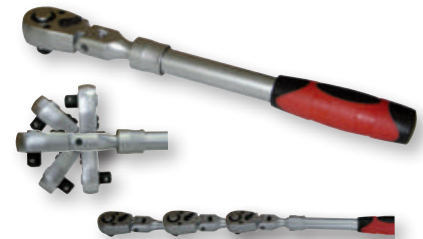

CRICCHETTO A 72 DENTI / 72-TOOTH RATCHET

In Cromo Vanadio, con bloccaggio.

Made of Chrome Vanadium, with socket locking.

DATI TECNICI / TECHNICAL DATA

ART.	05315	05316	05317
Attacco / Drive	1/4"	3/8"	1/2"

Confezione: supporto di plastica / Packaging: plastic support



CHIAVE DINAMOMETRICA / TORQUE WRENCH

In Cromo Vanadio.

Made of Chrome Vanadium.

DATI TECNICI / TECHNICAL DATA

ART.	E06031	
Attacco / Drive	1/2"	
Torsione / Torque range	Nm	30-210
Precisione / Accuracy	+/- 3 %	

Confezione: valigetta ABS / Packaging: ABS case



BUSSOLE E CRICCHETTI SOCKETS AND RATCHETS

SET 11 BUSSOLE MAGNETICHE 11-PIECE MAGNETIC SOCKET SET

In Cromo Vanadio, attacco 1/2".

Made of Chrome Vanadium, 1/2" drive.

DATI TECNICI / TECHNICAL DATA

ART.	K00021		
Misura / Size	mm	10 - 12 - 13 - 14 - 15 - 16 17 - 18 - 19 - 22 - 23	

Confezione: valigetta ABS / Packaging: ABS case



SET BUSSOLE PASSANTI / PASS-THRU SOCKET SET

In Cromo Vanadio, con cricchetto a frizione.

Made of Chrome Vanadium, ratchet with clutch drive.

DATI TECNICI / TECHNICAL DATA

ART.	54347
-------------	--------------

COMPOSIZIONE:

- 1 cricchetto a frizione
- 1 snodo 3/8"
- 1 adattatore per bussole 3/8"
- 1 bussola per candele 16 mm
- 8 bussole 8 - 10 - 11 - 13 - 14 - 16 - 17 - 19 mm

CONTENT:

- 1 ratchet with clutch drive
- 1 joint 3/8"
- 1 socket adapter 3/8"
- 1 glow plug socket 16 mm
- 8 sockets 8 - 10 - 11 - 13 - 14 - 16 - 17 - 19 mm

Confezione: valigetta ABS / Packaging: ABS case



SET BUSSOLE ED INSERTI 35 PEZZI 35-PIECE SOCKET AND BIT SET

Inserti in S2 e bussole in Cromo Vanadio, finitura satinata lucida.

Bits made of S2, sockets of Chrome Vanadium, matte bright finish.

DATI TECNICI / TECHNICAL DATA

ART.	E09068	E02027
Confezione / Packaging	termoretraibile shrink film	valigetta ABS ABS case

COMPOSIZIONE:

- 1 cricchetto 72 denti
- 12 bussole 1/2" 15 - 16 - 17 - 18 - 19 - 20 - 21 - 22 - 24 - 27 - 30 - 32 mm
- 2 bussole lunghe 1/2" 17 - 19 mm
- 2 prolunghe 1/2" 125 - 250 mm
- 1 snodo universale 1/2"
- 1 chiave a T 1/2"
- 1 adattatore inserti 5/16"
- 2 inserti Phillips PH3 - 4
- 2 inserti Pozidriv PZ3 - 4
- 3 inserti a taglio 8 - 10 - 12 mm
- 4 inserti Torx T40 - 45 - 50 - 55
- 4 inserti esagonali 8 - 10 - 12 - 14 mm

CONTENT:

- 1 ratchet 72 teeth
- 12 sockets 1/2" 15 - 16 - 17 - 18 - 19 - 20 - 21 - 22 - 24 - 27 - 30 - 32 mm
- 2 long sockets 1/2" 17 - 19 mm
- 2 extensions 1/2" 125 - 250 mm
- 1 universal joint 1/2"
- 1 T-wrench 1/2"
- 1 bit adapter 5/16"
- 2 Phillips bits PH3 - 4
- 2 Pozidriv bits PZ3 - 4
- 3 slotted bits 8 - 10 - 12 mm
- 4 Torx bits T40 - 45 - T50 - T55
- 4 hex bits 8 - 10 - 12 - 14 mm



BUSSOLE E CRICCHETTI SOCKET AND RATCHETS

SET BUSSOLE ED INSERTI 45 PEZZI 45-PIECE SOCKET AND BIT SET

Inserti in S2 e bussole Cromo Vanadio, finitura satinata lucida.

Bits made of Chrome Vanadium, matte bright finish.

DATI TECNICI / TECHNICAL DATA

ART.	E09069	E02028
Confezione / Packaging	termoretraibile shrink film	valigetta ABS ABS case

COMPOSIZIONE:

- 1 cricchetto
- 13 bussole 1/4" 4 - 4,5 - 5 - 5,5 - 6 - 7 - 8 - 9 - 10 - 11 - 12 - 13 - 14 mm
- 3 bussole lunghe 1/4" 8 - 10 - 13 mm
- 2 prolunghe 1/4" 50 - 100 mm
- 1 prolunga flessibile 150 mm
- 1 snodo universale 1/4"
- 1 chiave a T 1/4"
- 1 adattatore per bussole 1/4"
- 3 chiavi esagonali 1,5 - 2 - 2,5 mm
- 3 inserti Phillips PH1 - 2 - 3
- 3 inserti Pozidriv PZ1 - 2 - 3
- 4 inserti a taglio 3 - 4 - 5 - 6 mm
- 5 inserti Torx T15 - 20 - 25 - 27 - 30
- 4 inserti esagonali 3 - 4 - 5 - 6 mm

CONTENT:

- 1 ratchet
- 13 sockets 1/4" 4 - 4,5 - 5 - 5,5 - 6 - 7 - 8 - 9 - 10 - 11 - 12 - 13 - 14 mm
- 3 long sockets 1/4" 8 - 10 - 13 mm
- 2 extensions 1/4" 50 - 100 mm
- 1 flexible extensions 150 mm
- 1 universal joint 1/4"
- 1 T-wrench 1/4"
- 1 socket adapter 1/4"
- 3 hex keys 1,5 - 2 - 2,5 mm
- 3 Phillips bits PH1 - 2 - 3
- 3 Pozidriv bits PZ1 - 2 - 3
- 4 slotted bits 3 - 4 - 5 - 6 mm
- 5 Torx bits T15 - 20 - 25 - 27 - 30
- 4 hex bits 3 - 4 - 5 - 6 mm



KIT BUSSOLE 30 PEZZI 30-PIECE SOCKETS SET

In Cromo Vanadio.

Made of Chrome Vanadium.

DATI TECNICI / TECHNICAL DATA

ART.	E05969
------	--------

COMPOSIZIONE:

- 1 cricchetto 72 denti
- 18 bussole 1/2" 8-9-10-11-12-13-14-15-16-17-18-19-21-22-24-27-30-32 mm
- 5 bussole lunghe 1/2" 10 - 13 - 14 - 17 - 19 mm
- 2 bussole per candele 1/2" 16 - 21 mm
- 2 prolunghe 1/2" 125 - 250 mm
- 1 snodo universale 1/2"
- 1 chiave a T 1/2"

CONTENT:

- 1 ratchet 72 teeth
- 18 sockets 1/2" 8-9-10-11-12-13-14-15-16-17-18-19-21-22-24-27-30-32 mm
- 5 long sockets 1/2" 10 - 13 - 14 - 17 - 19 mm
- 2 glow plug sockets 1/2" 16 - 21 mm
- 2 extensions 1/2" 125 - 250 mm
- 1 universal joint 1/2"
- 1 T-wrench 1/2"

Confezione: valigetta ABS / Packaging: ABS case



BUSSOLE E CRICCHETTI SOCKET AND RATCHETS

SET CHIAVI A BUSSOLA 24 PEZZI 24-PIECE SOCKETS WRENCH SET

In Cromo Vanadio.

Made of Chrome Vanadium.

DATI TECNICI / TECHNICAL DATA

ART.	E05940	E02005
Confezione / Packaging	termoretraibile shrink film	valigetta ABS ABS case

COMPOSIZIONE:

- 1 cricchetto 1/2"
- 17 bussole 1/2" 10-11-12-13-14-15-16-17-18-19-20-21-22-24-27-30-32 mm
- 2 bussole per candele 1/2" 16 - 21 mm
- 1 snodo universale 1/2"
- 2 prolunghe 125 - 250 mm
- 1 adattatore

CONTENT:

- 1 ratchet 1/2"
- 17 sockets 1/2" 10-11-12-13-14-15-16-17-18-19-20-21-22-24-27-30-32 mm
- 2 glow plug sockets 1/2" 16 - 21 mm
- 1 universal joint 1/2"
- 1 extensions 125 - 250 mm
- 1 adapter



SET CHIAVI E INSERTI A BUSSOLA 41 PEZZI 41-PIECE SOCKET WRENCH AND BIT SET

Bussole in Cromo Vanadio e inserti in S2.

Sockets made of Chrome Vanadium, bits of S2.

DATI TECNICI / TECHNICAL DATA

ART.	E05941	E02015
Confezione / Packaging	termoretraibile shrink film	valigetta ABS ABS case

COMPOSIZIONE:

- 1 cricchetto
- 12 bussole 4 - 4,5 - 5 - 5,5 - 6 - 7 - 8 - 9 - 10 - 11 - 12 - 13 mm
- 5 bussole lunghe 6 - 7 - 8 - 10 - 13 mm
- 4 inserti esagonali 3 - 4 - 5 - 6 mm
- 3 inserti a taglio 4 - 5,5 - 7 mm
- 2 inserti Phillips PH1 - 2
- 2 inserti Pozidriv PZ1 - 2
- 6 inserti Torx T8 - 10 - 15 - 20 - 25 - 30
- 1 giravite 1/4"
- 2 prolunghe 50 - 100 mm
- 1 prolunga flessibile
- 1 snodo universale
- 1 chiave a T

CONTENT:

- 1 ratchet
- 12 sockets 4 - 4,5 - 5 - 5,5 - 6 - 7 - 8 - 9 - 10 - 11 - 12 - 13 mm
- 5 long sockets 6 - 7 - 8 - 10 - 13 mm
- 4 hex bits 3 - 4 - 5 - 6 mm
- 3 slotted bits 4 - 5,5 - 7 mm
- 2 Phillips bits PH1 - 2
- 2 Pozidriv bits PZ1 - 2
- 6 Torx bits T8 - 10 - 15 - 20 - 25 - 30
- 1 screwdriver 1/4"
- 2 extensions 50 - 100 mm
- 1 flexible extension
- 1 universal joint
- 1 T-wrench



BUSSOLE E CRICCHETTI SOCKET AND RATCHETS

SET BUSSOLE SUPERLOCK E INSERTI 31 PEZZI 31-PIECE SUPERLOCK SOCKET AND BIT SET

In Cromo Vanadio.

Made of Chrome Vanadium.

DATI TECNICI / TECHNICAL DATA

ART.	E05942	E02014
Confezione / Packaging	termoretraibile shrink film	valigetta ABS ABS case

COMPOSIZIONE:

- 6 bussole 1/2" 10 - 13 - 14 - 15 - 17 - 19 mm
- 8 bussole 1/4" 6 - 7 - 8 - 9 - 10 - 11 - 12 - 13 mm
- 4 inserti a bussola esagonali 3 - 4 - 5 - 6 mm
- 3 inserti a bussola taglio 4 - 5,5 - 7 mm
- 2 inserti a bussola Phillips PH1 - 2
- 2 inserti a bussola Pozidriv PZ1 - 2
- 6 inserti a bussola Torx T8 - 10 - 15 - 20 - 25 - 30

CONTENT:

- 6 sockets 1/2" 10 - 13 - 14 - 15 - 17 - 19 mm
- 8 sockets 1/4" 6 - 7 - 8 - 9 - 10 - 11 - 12 - 13 mm
- 4 hex socket bits 3 - 4 - 5 - 6 mm
- 3 slotted socket bits 4 - 5,5 - 7 mm
- 2 Phillips socket bits PH1 - 2
- 2 Pozidriv socket bits PZ1 - 2
- 6 Torx socket bits T8 - 10 - 15 - 20 - 25 - 30



SET BUSSOLE MULTI-POINT 38 PEZZI 38-PIECE MULTI-POINT SOCKET SET

In Cromo Vanadio. Il particolare profilo della bussola consente il serraggio di diversi tipi di bulloni.

Made of Chrome Vanadium.
The socket profile allows to tighten different types of bolt.

DATI TECNICI / TECHNICAL DATA

ART.	E05939
------	--------

COMPOSIZIONE:

- 2 cricchetti 1/2" - 1/4"
- 16 bussole 1/2" 10 - 11 - 12 - 13 - 14 - 15 - 16 - 17 - 18 - 19 - 22 - 23 - 24 - 27 - 30 - 32 mm
- 11 bussole 1/4" 4 - 5 - 6 - 7 - 8 - 9 - 10 - 11 - 12 - 13 - 14 mm
- 2 prolunghe 1/2" 125 - 250 mm
- 2 prolunghe 1/4" 50 - 100 mm
- 2 snodi universali 1/2" - 1/4"
- 2 chiavi a T 1/2" - 1/4"
- 1 prolunga flessibile

CONTENT:

- 2 ratchets 1/2" - 1/4"
- 16 sockets 1/2" 10 - 11 - 12 - 13 - 14 - 15 - 16 - 17 - 18 - 19 - 22 - 23 - 24 - 27 - 30 - 32 mm
- 11 sockets 1/4" 4 - 5 - 6 - 7 - 8 - 9 - 10 - 11 - 12 - 13 - 14 mm
- 2 extensions 1/2" 125 - 250 mm
- 2 extensions 1/4" 50 - 100 mm
- 2 universal joints 1/2" - 1/4"
- 2 T-wrenches 1/2" - 1/4"
- 1 flexible extension

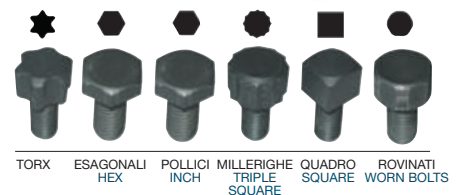

TORX ESAGONALI HEX POLLICI INCH MILLERIGHE TRIPLE SQUARE QUADRO SQUARE ROVINATI WORN BOLTS

Confezione: valigetta ABS / Packaging: ABS case

BUSSOLE E CRICCHETTI SOCKET AND RATCHETS

SET BUSSOLE 46 PEZZI 46-PIECE SOCKET SET

In Cromo Vanadio.

Made of Chrome Vanadium.

DATI TECNICI / TECHNICAL DATA

ART. E05968

COMPOSIZIONE:

- 1 cricchetto 45 denti
- 13 bussole 1/4" 4 - 4,5 - 5 - 5,5 - 6 - 7 - 8 - 9 - 10 - 11 - 12 - 13 - 14 mm
- 6 inserti a bussola esagonali 3 - 4 - 5 - 6 - 7 - 8 mm
- 3 inserti a bussola taglio 4 - 5,5 - 7 mm
- 3 inserti a bussola Phillips PH1 - 2 - 3
- 2 inserti a bussola Pozidriv PZ1 - 2
- 7 inserti a bussola Torx T10 - 15 - 20 - 25 - 27 - 30 - 40
- 1 adattatore per bussole
- 2 prolunghe 1/4" 50 - 100 mm
- 1 prolunga flessibile 150 mm
- 1 snodo universale 1/4"
- 1 chiave a T 1/4"
- 4 chiavi esagonali 1,27 - 1,5 - 2 - 2,5 mm
- 1 giravite portabussole 1/4"

CONTENT:

- 1 ratchet 45 teeth
- 13 sockets 1/4" 4 - 4,5 - 5 - 5,5 - 6 - 7 - 8 - 9 - 10 - 11 - 12 - 13 - 14 mm
- 6 hex socket bits 3 - 4 - 5 - 6 - 7 - 8 mm
- 3 slotted socket bits 4 - 5,5 - 7 mm
- 3 Phillips socket bits PH1 - 2 - 3
- 2 Pozidriv socket bits PZ1 - 2
- 7 Torx socket bits T10 - 15 - 20 - 25 - 27 - 30 - 40
- 1 socket adapter
- 2 extensions 1/4" 50 - 100 mm
- 1 flexible extension
- 1 universal joint 1/4"
- 1 T-wrench 1/4"
- 4 hex keys 1,27 - 1,5 - 2 - 2,5 mm
- 1 socket holder screwdriver 1/4"

Confezione: valigetta ABS / Packaging: ABS case



SET BUSSOLE E CRICCHETTI 65 PEZZI 65-PIECE SOCKET AND BIT SET

In Cromo Vanadio.

Made of Chrome Vanadium.

DATI TECNICI / TECHNICAL DATA

ART. K00020

COMPOSIZIONE:

- 1 cricchetto 72 denti
- 8 bussole 1/4" 7 - 8 - 9 - 10 - 11 - 12 - 13 - 14 mm
- 6 bussole Torx 1/4" E4 - 5 - 6 - 7 - 8 - 10
- 6 bussole Torx 3/8" E12 - 14 - 16 - 18
- 8 inserti a bussola 3/8" T27 - 30 - 40 - 45 - 47 - 50 - 55 - 60
- 1 adattatore 3/8" femmina - 1/4" maschio
- 1 prolunga 75 mm
- 1 portainseri 60 mm
- 32 inserti 1/4"
- 1 vaschetta magnetica

CONTENT:

- 1 ratchet 72 teeth
- 8 sockets 1/4" 7 - 8 - 9 - 10 - 11 - 12 - 13 - 14 mm
- 6 Torx sockets 1/4" E4 - 5 - 6 - 7 - 8 - 10
- 6 Torx sockets 3/8" E12 - 14 - 16 - 18
- 8 sockets bits 3/8" T27 - 30 - 40 - 45 - 47 - 50 - 55 - 60
- 1 adapter 3/8" female - 1/4" male
- 1 extension 75 mm
- 1 bit holder 60 mm
- 32 bits 1/4"
- 1 magnetic tray

Confezione: valigetta magnetica in ABS / Packaging: magnetic ABS case



CHIAVI WRENCHES

CHIAVI A CRICCHETTO SNODATE COMBinate FLEXI-HEAD RATCHET COMBINATION WRENCHES

In Cromo Vanadio, con finitura cromata.

Made of Chrome Vanadium, with chromed finish.



DATI TECNICI / TECHNICAL DATA

ART.	E86170	E86171	E86172	E86173	E86174	
Misura / Size	mm	8	10	11	12	13
ART.	E86175	E86176	E86177	E86178	E86179	
Misura / Size	mm	14	15	16	17	19

Confezione: supporto in plastica / Packaging: plastic support

CHIAVI A CRICCHETTO COMBinate RATCHET COMBINATION WRENCHES

In Cromo Vanadio, con finitura cromata, tipologia reversibile.

Made of Chrome Vanadium, with chromed finish. Reversible.



DATI TECNICI / TECHNICAL DATA

ART.	E86120	E86121	E86122	E86123	E86124	
Misura / Size	mm	8	10	12	13	14
ART.	E86125	E86126	E86127			
Misura / Size	mm	15	16	17		

Confezione: supporto in plastica / Packaging: plastic support

CHIAVI A CRICCHETTO CORTE COMBinate STUBBY RATCHET COMBINATION WRENCHES

In Cromo Vanadio, con finitura cromata, tipologia reversibile. Ideale per serreggi in luoghi poco accessibili.

Made of Chrome Vanadium, with chromed finish. Reversible. Thin wall design for greater access.



DATI TECNICI / TECHNICAL DATA

ART.	E86140	E86141	E86142	E86143	E86144	
Misura / Size	mm	8	10	12	13	14
ART.	E86145	E86146	E86147	E86148		
Misura / Size	mm	15	16	17	19	

Confezione: supporto in plastica / Packaging: plastic support

SET 4 ADATTATORI 4-PIECE SOCKET ADAPTOR SET

In Cromo Vanadio, con finitura cromata. Con pulsante bloccabussola. Compatibile con qualsiasi tipo di chiave.

Made of Chrome Vanadium, with chromed finish. Socket locking. Suitable for all wrenches.

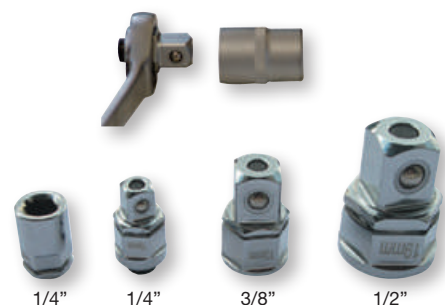

DATI TECNICI / TECHNICAL DATA

ART.	E86180
Misura / Size	1/4" - 3/8" - 1/2"
Portainseriti / Bit holder	1/4"

Confezione: blister / Packaging: blister

CHIAVI WRENCHES

CHIAVI COMBinate COMBINATION WRENCHES

In Cromo Vanadio con finitura cromata sabbiata, testa cromata lucida.

Made of Chrome Vanadium with sandblasted chromed finish, bright chromed head.

DATI TECNICI / TECHNICAL DATA

ART.	Misura / Size	A	B	C	D
	mm	mm	mm	mm	mm
05323	6	107	16	10	4
05324	7	107	17	13	4
05325	8	125	20	13	4,2
05326	9	135	22	14	4,2
05327	10	143	23	16	4,2
05328	11	154	25	17	4,2
05329	12	165	28	19	4,6
05330	13	174	29	20	4,6
05331	14	184	31	21	5,5
05332	15	197	35	23	5,5
05333	16	203	37	24	5,5
05334	17	212	39	26	6
05335	18	221	41	27	6,2
05336	19	234	41	28	6,2
05337	20	245	43	29	6,2
05338	21	249	46	30	6,5
05339	22	258	49	33	7
05340	23	268	51	34	7,5
05341	24	275	53	34	7,5
05342	25	280	54	37	8
05343	26	287	55	38	8,2
05344	27	295	57	39	8,5
05345	28	302	61	40	8,5
05346	30	305	63	44	9
05347	32	312	68	44	9

Confezione: supporto in plastica - Precisione secondo norme: DIN 3113-899 ISO 3318 UNI 6741
Packaging: plastic support - Accuracy according to: DIN 3113-899 ISO 3318 UNI 6741

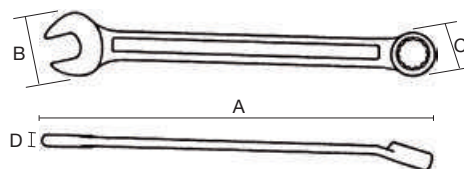

CHIAVI A FORCHETTA DOPPIE DOUBLE OPEN END WRENCHES

In Cromo Vanadio con finitura cromata sabbiata, testa cromata lucida.

Made of Chrome Vanadium with sandblasted chromed finish, bright chromed head.

DATI TECNICI / TECHNICAL DATA

ART.	Misura / Size	A	B	C	D
	mm	mm	mm	mm	mm
05411	6x7	124	15	17	3,5
05412	8x9	143	20	22	4,2
05414	10x11	156	23	26	4,5
05417	12x13	170	28	30	4,9
05420	14x15	186	32	34	4,9
05422	16x17	205	35	37	5
05424	18x19	220	40	42	6
05427	20x22	223	44	49	6,4
05428	21x23	240	46	50	7
05430	24x26	255	52	56	7,6
05432	25x28	266	54	60	8
05434	30x32	290	63	67	8

Precisione secondo norme: DIN 3110-899 ISO 3318 UNI 6736
Accuracy according to: DIN 3110-899 ISO 3318 UNI 6736

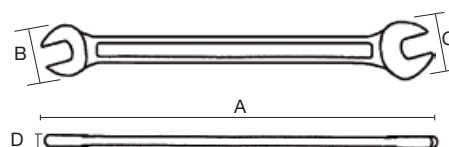

CHIAVI WRENCHES

CHIAVI POLIGONALI EXTRALUNGHE EXTRA LONG BOX-END WRENCHES

In Cromo Molibdeno con finitura cromata lucida. Il particolare profilo della chiave consente il serraggio di diversi tipi di bulloni.

Made of Chrome Molybdenum with bright chrome finish. The socket profile allows to tighten different types of bolt.

DATI TECNICI / TECHNICAL DATA

ART.	Misura / Size	A	B	C
	mm	mm	mm	mm
K50032	10x11	235	15	20
K50033	12x14	370	20	22
K50034	13x15	370	22	26
K50035	17x19	405	26	29
K50036	22x24	435	32	35

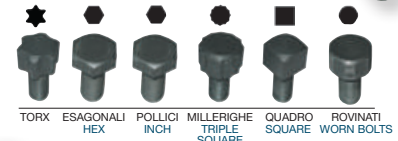
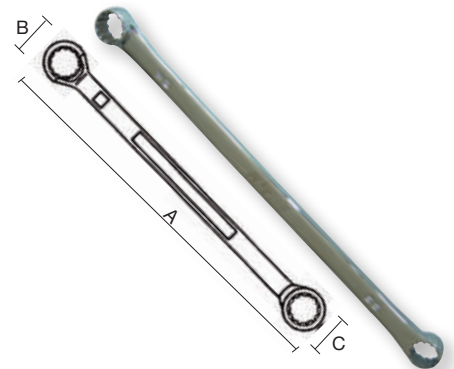

CHIAVI POLIGONALI DOPPIE DOUBLE BOX-END WRENCHES

In Cromo Vanadio con finitura cromata sabbata.

Made of Chrome Vanadium with sandblasted chromed finish.

DATI TECNICI / TECHNICAL DATA

ART.	Misura / Size	A	B	C	D
	mm	mm	mm	mm	mm
05460	6x7	180	11	12	5,5
05461	8x9	190	15	16	7,5
05462	10x11	210	17	18	9
05463	12x13	229	20	21	9,5
05464	14x15	255	24	25	11,5
05465	16x17	274	25	26	12
05466	18x19	293	29	29	12
05467	20x22	310	32	35	13
05468	21x23	330	34	35	14,5
05469	24x26	350	37	39	15
05470	25x28	370	38	42	15,5
05472	30x32	390	42	50	16,5

Confezione: supporto in plastica - Precisione secondo norme: DIN 838-899 ISO 3318
Packaging: plastic support - Accuracy according to: DIN 838-899 ISO 3318

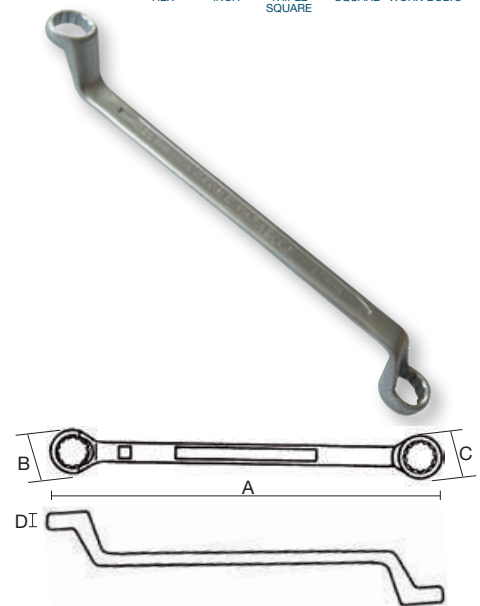

SET CHIAVI A CRICCHETTO SNODATE FLEXI-HEAD RATCHET COMBINATION WRENCH SET

In Cromo Vanadio.

Made of Chrome Vanadium.

DATI TECNICI / TECHNICAL DATA

ART. **E86114**

COMPOSIZIONE:

- 6 chiavi a cricchetto snodate 8 - 10 - 12 - 13 - 17 - 19 mm
- 3 adattatori 1/2" - 1/4" - 3/8"

CONTENT:

- 6 flexi-head ratchet combination wrenches 8 - 10 - 12 - 13 - 17 - 19 mm
- 3 adapters 1/2" - 1/4" - 3/8"

Confezione: valigetta ABS / Packaging: ABS case



SET CHIAVI COMBinate A CRICCHETTO CORTE STUBBY RATCHET COMBINATION WRENCH SET

In Cromo Vanadio.

Made of Chrome Vanadium.

DATI TECNICI / TECHNICAL DATA

ART. **E86113**

COMPOSIZIONE:

- 7 chiavi a cricchetto 8 - 10 - 12 - 13 - 14 - 17 - 19 mm
- 3 adattatori 1/2" - 1/4" - 3/8"

CONTENT:

- 7 ratchet combination wrenches 8 - 10 - 12 - 13 - 14 - 17 - 19 mm
- 3 adapters 1/2" - 1/4" - 3/8"

Confezione: valigetta ABS / Packaging: ABS case



CHIAVI WRENCHES

SET CHIAVI COMBinate A CRICCHETTO RATCHET COMBINATION WRENCH SET

In Cromo Vanadio con finitura cromata.

Made of Chrome Vanadium with chromed finish.

DATI TECNICI / TECHNICAL DATA

ART.	E07003	E02012
Confezione / Packaging	termoretraibile shrink film	valigetta ABS ABS case
Misura / Size	mm	6 - 8 - 10 - 12 - 13 - 14 - 17 - 19



SET 14 CHIAVI COMBinate 14-PIECE COMBINATION WRENCH SET

In Cromo Vanadio con finitura cromata sabbata.

Made of Chrome Vanadium with sandblasted chromed finish.

DATI TECNICI / TECHNICAL DATA

ART.	E07016	E02008
Confezione / Packaging	termoretraibile shrink film	valigetta ABS ABS case
Misura / Size	mm	6 - 7 - 8 - 9 - 10 - 11 - 12 - 13 - 14 - 15 - 16 - 17 - 19 - 22

Precisione secondo norme: DIN 3113-899 ISO 3318 UNI 6741
Accuracy according to: DIN 3113-899 ISO 3318 UNI 6741



SET 8 CHIAVI COMBinate 8-PIECE COMBINATION WRENCH SET

In Cromo Vanadio con finitura cromata sabbata.

Made of Chrome Vanadium with sandblasted chromed finish.

DATI TECNICI / TECHNICAL DATA

ART.	E07008	E07009
Confezione / Packaging	termoretraibile shrink film	valigetta ABS ABS case
Misura / Size	mm	23 - 24 - 25 - 26 - 27 - 28 - 30 - 32

Precisione secondo norme: DIN 3113-899 ISO 3318 UNI 6741
Accuracy according to: DIN 3113-899 ISO 3318 UNI 6741



SET 8 CHIAVI COMBinate 8-PIECE COMBINATION WRENCH SET

In Cromo Vanadio con finitura cromata sabbata.

Made of Chrome Vanadium with sandblasted chromed finish.

DATI TECNICI / TECHNICAL DATA

ART.	E07000
Misura / Size	mm

Confezione: supporto in plastica appendibile
Precisione secondo norme: DIN 3113-899 ISO 3318 UNI 6741
Packaging: plastic tray that can be hung - Accuracy according to: DIN 3113-899 ISO 3318 UNI 6741



SET 12 CHIAVI COMBinate 12-PIECE COMBINATION WRENCH SET

In Cromo Vanadio con finitura cromata sabbata.

Made of Chrome Vanadium with sandblasted chromed finish.

DATI TECNICI / TECHNICAL DATA

ART.	E07001
Misura / Size	mm

Confezione: supporto in plastica appendibile
Precisione secondo norme: DIN 3113-899 ISO 3318 UNI 6741
Packaging: plastic tray that can be hung - Accuracy according to: DIN 3113-899 ISO 3318 UNI 6741



CHIAVI WRENCHES

SET 8 CHIAVI A FORCHETTA 8-PIECE DOUBLE OPEN END WRENCH SET

In Cromo Vanadio con finitura cromata sabbata.

Made of Chrome Vanadium with sandblasted chromed finish.

DATI TECNICI / TECHNICAL DATA

ART.	E07002	
Misura / Size	mm	6x7 - 8x9 - 10x11 - 12x13 14x15 - 16x17 - 18x19 - 20x22

Confezione: supporto in plastica appendibile
Precisione secondo norme: DIN 3113-899 ISO 3318 UNI 6741
Packaging: plastic tray that can be hung - Accuracy according to: DIN 3113-899 ISO 3318 UNI 6741



SET 12 CHIAVI A FORCHETTA 12-PIECE DOUBLE OPEN END WRENCH SET

In Cromo Vanadio con finitura cromata sabbata.

Made of Chrome Vanadium with sandblasted chromed finish.

DATI TECNICI / TECHNICAL DATA

ART.	E07004	
Misura / Size	mm	6x7 - 8x9 - 10x11 - 12x13 - 14x15 - 16x17 18x19 - 20x22 - 21x23 - 24x26 - 25x28 - 30x32

Confezione: supporto in plastica appendibile
Precisione secondo norme: DIN 3113-899 ISO 3318 UNI 6741
Packaging: plastic tray that can be hung - Accuracy according to: DIN 3113-899 ISO 3318 UNI 6741



SET 11 CHIAVI A FORCHETTA 11-PIECE DOUBLE OPEN END WRENCH SET

In Cromo Vanadio con finitura cromata sabbata e testa cromata lucida.

Made of Chrome Vanadium with sandblasted chromed finish and bright chromed head.

DATI TECNICI / TECHNICAL DATA

ART.	E07014	E02010
Confezione / Packaging	termoretraibile shrink film	valigetta ABS ABS case
Misura / Size	mm	6x7 - 8x9 - 10x11 - 12x13 - 14x15 - 16x17 18x19 - 20x22 - 21x23 - 24x26 - 30x32

Precisione secondo norme: DIN 3110-899 ISO 3318 UNI 6736
Accuracy according to: DIN 3110-899 ISO 3318 UNI 6736



SET 9 CHIAVI ESAGONALI 9-PIECE HEX KEY SET

In acciaio S2. Adatto per svitare dadi rovinati.

Made of S2 steel. Suitable for worn bolts.

DATI TECNICI / TECHNICAL DATA

ART.	E93043	
Misura / Size	mm	1,5 - 2 - 2,5 - 3 - 4 - 5 - 6 - 8 - 10



Espositore da 15 pezzi
15-pieces display



CHIAVI WRENCHES

SET 7 CHIAVI ESAGONALI RICHIUDIBILI 7-PIECE FOLDING HEX KEY SET

In acciaio Cromo Vanadio.

Made of Chrome Vanadium steel.

DATI TECNICI / TECHNICAL DATA

ART.	E93051		
Misura / Size	mm	1,5 - 2 - 2,5 - 3 - 4 - 5 - 6	



Espositore da 10 pezzi
10-pieces display



SET 8 CHIAVI TORX RICHIUDIBILI 8-PIECE FOLDING TORX KEY SET

In acciaio Cromo Vanadio.

Made of Chrome Vanadium steel.

DATI TECNICI / TECHNICAL DATA

ART.	E93050		
Misura / Size	T	9 - 10 - 15 - 20 - 25 - 27 - 30 - 40	



Espositore da 10 pezzi
10-piece display



SET 9 CHIAVI RIVESTITE CON ESTREMITÀ SFERICA 9-PIECE COATED BALL END HEX KEY SET

In acciaio S2.

Made of S2 steel.

DATI TECNICI / TECHNICAL DATA

ART.	E93023		
Misura / Size	mm	1,5 - 2 - 2,5 - 3 - 4 - 5 - 6 - 8 - 10	

Confezione: blister / Packaging: blister



SET 9 CHIAVI TORX SECURITY RIVESTITE 9-PIECE COATED TORX SECURITY KEY SET

In acciaio S2.

Made of S2 steel.

DATI TECNICI / TECHNICAL DATA

ART.	E93022		
Misura / Size	T	10 - 15 - 20 - 25 - 27 - 30 - 40 - 45 - 50	

Confezione: blister / Packaging: blister



SET 9 CHIAVI ESAGONALI CALAMITATE 9-PIECE HEX KEY SET WITH MAGNET

In acciaio S2. Con estremità sferica.

Made of S2 steel. With ball end.

DATI TECNICI / TECHNICAL DATA

ART.	E93024		
Misura / Size	mm	1,5 - 2 - 2,5 - 3 - 4 - 5 - 6 - 8 - 10	

Confezione: doppio blister / Packaging: double blister



CHIAVI WRENCHES

CHIAVI A T ESAGONALI / T-HANDLE HEX KEYS

In acciaio S2 con impugnatura in bicomponente. Made of steel S2 with bi-material handle.

DATI TECNICI / TECHNICAL DATA

ART.	E87090	E87091	E87092	E87093	E87094	
Misura / Size	mm	2,5x100	3x100	4x150	5x150	6x150
ART.	E87095	E87096				
Misura / Size	mm	8x200	10x200			



CHIAVI A T TORX / T-HANDLE TORX KEYS

In acciaio S2 con impugnatura in bicomponente. Made of steel S2 with bi-material handle.

DATI TECNICI / TECHNICAL DATA

ART.	E87080	E87081	E87082	E87083	E87084	
Misura / Size	T	10	20	25	27	30
ART.	E87085	E87086				
Misura / Size	T	40	50			



CHIAVI A T SNODATE SWIVEL-HEAD T-HANDLE SOCKETS

In Cromo Vanadio con finitura cromata satinata e asta scorrevole. Made of Chrome Vanadium with matte bright chromed finish and sliding handle.

DATI TECNICI / TECHNICAL DATA

ART.	E06036	E06037	E06038	E07005	E06039	
Misura / Size	mm	8	10	11	12	13
ART.	E06040	E07006	E07007	E06041	E06042	
Misura / Size	mm	14	15	16	17	19

Precisione secondo norme: DIN 896 ISO 2336 UNI 6743
Accuracy according to: DIN 896 ISO 2336 UNI 6743



CHIAVI A T SNODATE SWIVEL-HEAD T-HANDLE KEYS

In Cromo Vanadio con finitura cromata satinata. Made of Chrome Vanadium with matte chromed finish.

DATI TECNICI / TECHNICAL DATA

ART.	E05161	E05162
Misura / Size	1/4"	1/2"

Precisione secondo norme: DIN 896 ISO 2336 UNI 6743
Accuracy according to: DIN 896 ISO 2336 UNI 6743



SET 7 CHIAVI A T SNODATE 7-PIECE SWIVEL-HEAD T-HANDLE SOCKET SET

In Cromo Vanadio con finitura cromata satinata. Made of Chrome Vanadium with matte chromed finish.

DATI TECNICI / TECHNICAL DATA

ART.	E06035	
Misura / Size	mm	8 - 10 - 11 - 13 - 14 - 17 - 19

Precisione secondo norme: DIN 896 ISO 2336 UNI 6743
Accuracy according to: DIN 896 ISO 2336 UNI 6743



CHIAVI WRENCHES

CHIAVI A T ESAGONALI / T-HANDLE HEX KEY

In Cromo Vanadio con finitura cromata satinata ed estremità brunite. Asta scorrevole. Durezza 52 HRC.

Made of Chrome Vanadium with matte bright finish and burnished tips. Sliding handle. Hardness 52 HRC.

DATI TECNICI / TECHNICAL DATA						
ART.		E06058	E06059	E06060	E06061	E06062
Misura / Size	mm	2x130	2,5x130	3x130	3,5x130	4x180
ART.		E06063	E06064	E06065	E05170	E05171
Misura / Size	mm	4,5x180	5x180	6x210	7x210	8x210
ART.		E05172	E05173	E05174		
Misura / Size	mm	10x210	12x210	14x210		

CHIAVI A T TORX / T-HANDLE TORX KEYS

In Cromo Vanadio con finitura cromata satinata ed estremità brunite. Asta scorrevole. Durezza 52 HRC.

Made of Chrome Vanadium with matte bright finish and burnished tips. Sliding handle. Hardness 52 HRC.

DATI TECNICI / TECHNICAL DATA						
ART.		E06067	E06068	E06069	E06070	E06071
Misura / Size	T	10	15	20	25	27
ART.		E06072	E06073			
Misura / Size	T	30	40			

CHIAVI ESAGONALI SNODATE SWIVEL-HEAD HEX WRENCHES

In Cromo Vanadio.

Made of Chrome Vanadium.

DATI TECNICI / TECHNICAL DATA				
ART.		E86150	E86151	E86152
Misura / Size	mm	3x4	5x6	8x10

Confezione: supporto in plastica / Packaging: plastic support

CHIAVI TORX SNODATE / SWIVEL-HEAD TORX WRENCHES

In Cromo Vanadio.

Made of Chrome Vanadium.

DATI TECNICI / TECHNICAL DATA						
ART.		E86153	E86154	E86155	E86156	E86157
Misura / Size	T	15x20	25x27	30x40	40x50	55x60

Confezione: supporto in plastica / Packaging: plastic support

CHIAVI A BUSSOLA SNODATE SWIVEL-HEAD SOCKET WRENCHES

In Cromo Vanadio.

Made of Chrome Vanadium.

DATI TECNICI / TECHNICAL DATA				
ART.		E86158	E86159	E86160
Misura / Size	mm	8x9	10x11	12x13
ART.		E86161	E86162	E86163
Misura / Size	mm	14x15	16x17	18x19

Confezione: supporto in plastica / Packaging: plastic support

CHIAVE A CROCE RICHIUDIBILE / FOLDING LUG WRENCH

In Cromo Vanadio.

Made of Chrome Vanadium.

DATI TECNICI / TECHNICAL DATA	
ART.	E07400
Misura / Size	mm 17 - 19 - 21 - 23



CHIAVI WRENCHES

CHIAVI A T FEMMINA / FEMALE T-HANDLE WRENCHES

In Cromo Vanadio, con impugnatura antiscivolo da 30 cm. Made of Chrome Vanadium, with 30 cm anti-slip handle.

DATI TECNICI / TECHNICAL DATA					
ART.		E06074	E06075	E06076	E06078
Misura / Size	mm	8	9	10	12
ART.		E06079	E06080	E06081	E06082
Misura / Size	mm	13	14	17	19

Confezione: supporto in plastica / Packaging: plastic support



SET 7 CHIAVI A T ESAGONALI 7-PIECE T-HANDLE HEX KEY SET

In acciaio S2 con impugnatura in bicomponente. Made of steel S2 with bi-material handle.

DATI TECNICI / TECHNICAL DATA			
ART.		E01002	E02024
Confezione / Packaging		termoretraibile shrink film	valigetta ABS ABS case
Misura / Size	mm	2,5 - 3 - 4 - 5 - 6 - 8 - 10	



SET 6 CHIAVI A T TORX 6-PIECE T-HANDLE TORX KEY SET

In acciaio S2 con impugnatura in bicomponente. Made of steel S2 with bi-material handle.

DATI TECNICI / TECHNICAL DATA			
ART.		E01003	E02025
Confezione / Packaging		termoretraibile shrink film	valigetta ABS ABS case
Misura / Size	T	10 - 20 - 25 - 27 - 30 - 40	



SET 8 CHIAVI A T ESAGONALI 8-PIECE T-HANDLE HEX WRENCHES

In Cromo Vanadio con finitura cromata satinata ed estremità brunite. Asta scorrevole. Durezza 52 HRC. Made of Chrome Vanadium with matte bright finish and burnished tips. Sliding handle. Hardness 52 HRC.

DATI TECNICI / TECHNICAL DATA			
ART.		E01000	E02023
Confezione / Packaging		termoretraibile shrink film	valigetta ABS ABS case
Misura / Size	mm	2x130 - 2,5x130 - 3x130 - 3,5x130 4x180 - 4,5x180 - 5x180 - 6x210	



SET 7 CHIAVI A T TORX 7-PIECE T-HANDLE TORX WRENCHES

In Cromo Vanadio con finitura cromata satinata ed estremità brunite. Asta scorrevole. Durezza 52 HRC. Made of Chrome Vanadium with matte bright finish and burnished tips. Sliding handle. Hardness 52 HRC.

DATI TECNICI / TECHNICAL DATA			
ART.		E01001	E02022
Confezione / Packaging		termoretraibile shrink film	valigetta ABS ABS case
Misura / Size	T	10 - 15 - 20 - 25 - 27 - 30 - 40	



INSERTI BITS

INSERTI PROGRIP POZIDRIV POZIDRIV PROGRIP BITS

In acciaio S2 con punta zigrinata per una perfetta presa sulla vite.
Attacco esagonale 1/4".

Progrip bits made of S2 steel with knurled tip for excellent grip on the screw. 1/4" hex drive.



DATI TECNICI / TECHNICAL DATA

ART.	Misura Size	Lunghezza Length	Confezione Pack
	PZ	mm	pz / pcs
E05998	1	25	10
E05999	2	25	10
E06000	3	25	10

Il prezzo è inteso per 10 inserti / The price is for 10 bits

INSERTI PROGRIP PHILLIPS PHILLIPS PROGRIP BITS

In acciaio S2 con punta zigrinata per una perfetta presa sulla vite.
Attacco esagonale 1/4".

Progrip bits made of S2 steel with knurled tip for excellent grip on the screw. 1/4" hex drive.



DATI TECNICI / TECHNICAL DATA

ART.	Misura Size	Lunghezza Length	Confezione Pack
	PH	mm	pz / pcs
E05995	1	25	10
E05996	2	25	10
E05997	3	25	10

Il prezzo è inteso per 10 inserti / The price is for 10 bits

INSERTI PROGRIP A TAGLIO SLOTTED PROGRIP BITS

In acciaio S2 con punta zigrinata per una perfetta presa sulla vite.
Attacco esagonale 1/4".

Progrip bits made of S2 steel with knurled tip for excellent grip on the screw. 1/4" hex drive.



DATI TECNICI / TECHNICAL DATA

ART.	Misura Size	Lunghezza Length	Confezione Pack
	mm	mm	pz / pcs
E05990	4	25	10
E05991	5,5	25	10
E05992	6,5	25	10

Il prezzo è inteso per 10 inserti / The price is for 10 bits

INSERTI PROGRIP TORX SECURITY TORX SECURITY PROGRIP BITS

In acciaio S2 con punta zigrinata per una perfetta presa sulla vite.
Attacco esagonale 1/4".

Progrip bits made of S2 steel with knurled tip for excellent grip on the screw. 1/4" hex drive.



DATI TECNICI / TECHNICAL DATA

ART.	Misura Size	Lunghezza Length	Confezione Pack
	T	mm	pz / pcs
E05950	8	25	10
E05951	10	25	10
E05952	15	25	10
E05953	20	25	10
E05954	25	25	10
E05956	30	25	10
E05957	40	25	10

Il prezzo è inteso per 10 inserti / The price is for 10 bits

INSERTI BITS

INSERTI PROGRIP PHILLIPS PHILLIPS PROGRIP BITS

In acciaio S2 con punta zigrinata per una perfetta presa sulla vite. Attacco esagonale 1/4".

Progrid bits made of S2 steel with knurled tip for excellent grip on the screw. 1/4" hex drive.

DATI TECNICI / TECHNICAL DATA			
ART.	Misura Size	Lunghezza Length	Confezione Pack
	PH	mm	pz / pcs
E06002	1	50	10
E06003	2	50	10
E06004	3	50	10

Il prezzo è inteso per 10 inserti / The price is for 10 bits



INSERTI PROGRIP POZIDRIV POZIDRIV PROGRIP BITS

In acciaio S2 con punta zigrinata per una perfetta presa sulla vite. Attacco esagonale 1/4".

Progrid bits made of S2 steel with knurled tip for excellent grip on the screw. 1/4" hex drive.

DATI TECNICI / TECHNICAL DATA			
ART.	Misura Size	Lunghezza Length	Confezione Pack
	PZ	mm	pz / pcs
E06005	1	50	10
E06006	2	50	10
E06007	3	50	10

Il prezzo è inteso per 10 inserti / The price is for 10 bits



INSERTI PROGRIP A TAGLIO SLOTTED PROGRIP BITS

In acciaio S2 con punta zigrinata per una perfetta presa sulla vite. Attacco esagonale 1/4".

Progrid bits made of S2 steel with knurled tip for excellent grip on the screw. 1/4" hex drive.

DATI TECNICI / TECHNICAL DATA			
ART.	Misura Size	Lunghezza Length	Confezione Pack
	mm	mm	pz / pcs
E06008	4	50	10
E06009	5,5	50	10
E06010	6,5	50	10

Il prezzo è inteso per 10 inserti / The price is for 10 bits



INSERTI PROGRIP TORX SECURITY TORX SECURITY PROGRIP BITS

In acciaio S2 con punta zigrinata per una perfetta presa sulla vite. Attacco esagonale 1/4".

Progrid bits made of S2 steel with knurled tip for excellent grip on the screw. 1/4" hex drive.

DATI TECNICI / TECHNICAL DATA			
ART.	Misura Size	Lunghezza Length	Confezione Pack
	T	mm	pz / pcs
E05960	8	50	10
E05961	10	50	10
E05962	15	50	10
E05963	20	50	10
E05964	25	50	10
E05965	27	50	10
E05966	30	50	10
E05967	40	50	10

Il prezzo è inteso per 10 inserti / The price is for 10 bits



INSERTI BITS

SET 10 INSERTI PROGRIP 10-PIECE PROGRIP BIT SET

In acciaio S2 con punta zigrinata per una perfetta presa sulla vite.
Attacco esagonale 1/4".
Lunghezza 25 mm.

Progrip bits made of S2 steel with knurled tip for excellent grip on the screw. 1/4" hex drive.
Length 25 mm.

DATI TECNICI / TECHNICAL DATA

ART. **E06015**

COMPOSIZIONE:

- 3 inserti Phillips PH1 - 2 - 3
- 3 inserti Pozidriv PZ1 - 2 - 3
- 4 inserti a taglio 3 - 4 - 5,5 - 6,5 mm

CONTENT:

- 3 Phillips bits PH1 - 2 - 3
- 3 Pozidriv bits PZ1 - 2 - 3
- 4 slotted bits 3 - 4 - 5,5 - 6,5 mm

Confezione: doppio blister / Packaging: double blister

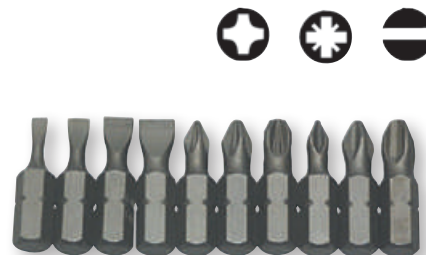

SET 10 INSERTI PROGRIP 10-PIECE PROGRIP BIT SET

In acciaio S2 con punta zigrinata per una perfetta presa sulla vite.
Attacco esagonale 1/4".
Lunghezza 50 mm.

Progrip bits made of S2 steel with knurled tip for excellent grip on the screw. 1/4" hex drive.
Length 50 mm.

DATI TECNICI / TECHNICAL DATA

ART. **E06020**

COMPOSIZIONE:

- 3 inserti Phillips PH1 - 2 - 3
- 3 inserti Pozidriv PZ1 - 2 - 3
- 4 inserti a taglio 3 - 4 - 5,5 - 6,5 mm

CONTENT:

- 3 Phillips bits PH1 - 2 - 3
- 3 Pozidriv bits PZ1 - 2 - 3
- 4 slotted bits 3 - 4 - 5,5 - 6,5 mm

Confezione: doppio blister / Packaging: double blister

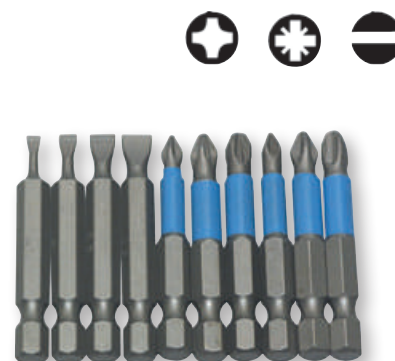

INSERTI TORX / TORX BITS

In acciaio S2, attacco esagonale 3/8". Made of S2 steel, 3/8" hex drive.

DATI TECNICI / TECHNICAL DATA

ART.	Misura / Size	Lunghezza / Length
	T	mm
E07200	20	30
E07201	25	30
E07202	27	30
E07203	30	30
E07204	40	30
E07205	45	30
E07206	50	30
E07207	55	30
E07208	60	30



INSERTI BITS

INSERTI TORX / TORX BITS

In acciaio S2, attacco esagonale 3/8". Made of S2 steel, 3/8" hex drive.

DATI TECNICI / TECHNICAL DATA		
ART.	Misura / Size	Lunghezza / Length
	T	mm
E07250	20	75
E07251	25	75
E07252	27	75
E07253	30	75
E07254	40	75
E07255	45	75
E07256	50	75
E07257	55	75
E07258	60	75



INSERTI ESAGONALI / HEX BITS

In acciaio S2, attacco esagonale 3/8". Made of S2 steel, 3/8" hex drive.

DATI TECNICI / TECHNICAL DATA		
ART.	Misura / Size	Lunghezza / Length
	mm	mm
E07210	4	30
E07211	5	30
E07212	6	30
E07213	7	30
E07214	8	30
E07215	10	30
E07216	12	30



INSERTI ESAGONALI / HEX BITS

In acciaio S2, attacco esagonale 3/8". Made of S2 steel, 3/8" hex drive.

DATI TECNICI / TECHNICAL DATA		
ART.	Misura / Size	Lunghezza / Length
	T	mm
E07260	4	75
E07261	5	75
E07262	6	75
E07263	7	75
E07264	8	75
E07265	10	75
E07266	12	75



INSERTI HALF TITANIUM PHILLIPS PHILLIPS HALF TITANIUM BITS

Rivestimento superficiale in nitrato di titanio, attacco esagonale 1/4". Titanium nitrate coating, 1/4" hex drive.

DATI TECNICI / TECHNICAL DATA			
ART.	Misura Size	Lunghezza Length	Confezione Pack
	PH	mm	pz / pcs
E06200	1	25	10
E06201	2	25	10
E06202	3	25	10

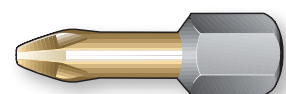

INSERTI BITS

INSERTI HALF TITANIUM POZIDRIV POZIDRIV HALF TITANIUM BITS

Rivestimento superficiale in nitrato di titanio, attacco esagonale 1/4".

Titanium nitrate coating, 1/4" hex drive.

DATI TECNICI / TECHNICAL DATA

ART.	Misura Size	Lunghezza Length	Confezione Pack
	PZ	mm	pz / pcs
E06203	1	25	10
E06204	2	25	10
E06205	3	25	10

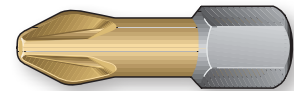

INSERTI HALF TITANIUM TORX TORX HALF TITANIUM BITS

Rivestimento superficiale in nitrato di titanio, attacco esagonale 1/4".

Titanium nitrate coating, 1/4" hex drive.

DATI TECNICI / TECHNICAL DATA

ART.	Misura Size	Lunghezza Length	Confezione Pack
	T	mm	pz / pcs
E06206	10	25	3
E06207	15	25	3
E06208	20	25	3
E06209	25	25	3
E06210	30	25	3
E06211	40	25	3



INSERTI HALF TITANIUM PHILLIPS PHILLIPS HALF TITANIUM BITS

Rivestimento superficiale in nitrato di titanio, attacco esagonale 1/4".

Titanium nitrate coating, 1/4" hex drive.

DATI TECNICI / TECHNICAL DATA

ART.	Misura Size	Lunghezza Length	Confezione Pack
	PH	mm	pz / pcs
E06212	1	50	10
E06213	2	50	10
E06214	3	50	10



INSERTI HALF TITANIUM POZIDRIV POZIDRIV HALF TITANIUM BITS

Rivestimento superficiale in nitrato di titanio, attacco esagonale 1/4".

Titanium nitrate coating, 1/4" hex drive.

DATI TECNICI / TECHNICAL DATA

ART.	Misura Size	Lunghezza Length	Confezione Pack
	PZ	mm	pz / pcs
E06215	1	50	10
E06216	2	50	10
E06217	3	50	10



INSERTI A BUSSOLA PHILLIPS PHILLIPS SOCKET BITS

In acciaio S2, attacco 1/4".

Made of S2, 1/4" drive.

DATI TECNICI / TECHNICAL DATA

ART.	E07035		E07036
Misura / Size	PH	1	2

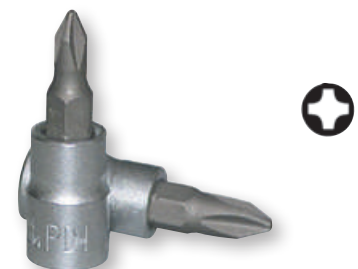

INSERTI BITS

INSERTI A BUSSOLA POZIDRIV POZIDRIV SOCKET BITS

In acciaio S2, attacco 1/4".

Made of S2 steel, 1/4" drive.

DATI TECNICI / TECHNICAL DATA

ART.	E07060	E07061
Misura / Size	PZ 1	2



INSERTI A BUSSOLA A TAGLIO SLOTTED SOCKET BITS

In acciaio S2, attacco 1/4".

Made of S2 steel, 1/4" drive.

DATI TECNICI / TECHNICAL DATA

ART.	E07030	E07031	E07032
Misura / Size	mm 4	5,5	7



INSERTI A BUSSOLA ESAGONALI HEX SOCKET BITS

In acciaio S2, attacco 1/4".

Made of S2 steel, 1/4" drive.

DATI TECNICI / TECHNICAL DATA

ART.	E07040	E07041	E07042	E07043
Misura / Size	mm 3	4	5	6



INSERTI A BUSSOLA TORX TORX SOCKET BITS

In acciaio S2, attacco 1/4".

Made of S2 steel, 1/4" drive.

DATI TECNICI / TECHNICAL DATA

ART.	Misura Size
	T
E07050	8
E07051	10
E07052	15
E07053	20
E07054	25
E07055	30



GIRAVITE PORTABUSSOLE / SOCKET DRIVER

In Cromo Vanadio, attacco 1/4".

Made of Chrome Vanadium,
1/4" drive.

ART.
05949

Confezione: supporto in plastica / Packaging: plastic support



PORTAINSERI / BIT HOLDER

In Cromo Vanadio, attacco 1/4".

Made of Chrome Vanadium,
1/4" drive.

ART.
E05993



INSERTI BITS

PORTAINSERTI MAGNETICO / MAGNETIC BIT HOLDER

In Cromo Vanadio, attacco 1/4".

Made of Chrome Vanadium,
1/4" drive.

ART.
E06001



ADATTATORE MAGNETICO / MAGNETIC ADAPTOR

DATI TECNICI / TECHNICAL DATA

ART.	Portainserito Bit holder	Accoppiamento Drive	Lunghezza Length
	DIN 3126	DIN 3126	mm
E05994	1/4"	1/4"	60

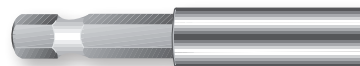

ADATTATORE PER INSERTI / BIT ADAPTOR

In Cromo Vanadio, attacco 1/2", adatto per inserti 3/8".

Made of Chrome Vanadium, 1/2" drive, suitable for 3/8" bits.

ART.
05956

Confezione: supporto in plastica / Packaging: plastic support



GIRAVITE DI PRECISIONE 11 IN 1 SCREWDRIVER WITH 11 BITS

In Cromo Vanadio.

Made of Chrome Vanadium.

DATI TECNICI / TECHNICAL DATA

ART. **E07245**

COMPOSIZIONE:

- 3 inserti a taglio 1,5 - 2 - 2,5 mm
- 3 inserti Phillips PH00 - 0 - 1
- 4 inserti Torx T4 - 5 - 6 - 7
- 1 prolunga 70 mm

CONTENT:

- 3 slotted bits 1,5 - 2 - 2,5 mm
- 3 Phillips bits PH00 - 0 - 1
- 4 Torx bits T4 - 5 - 6 - 7
- 1 extension 70 mm



Espositore 6 pezzi
6-piece display



SET INSERTI COLORATI CON PORTAINSERTI MAGNETICO 32 PEZZI 32-PIECE COLOR-CODED BIT SET WITH MAGNETIC BIT HOLDER

In acciaio S2.

Made of S2 steel.

DATI TECNICI / TECHNICAL DATA

ART. **E06011**

COMPOSIZIONE:

- 4 inserti esagonali 3 - 4 - 5 - 6 mm
- 4 inserti a taglio 3 - 4 - 5 - 6 mm
- 4 inserti Phillips PH1 - 2 - 2 - 3
- 4 inserti Pozidriv PZ1 - 2 - 2 - 3
- 7 inserti Torx T10 - 15 - 20 - 25 - 27 - 30 - 40
- 7 inserti Torx Security T10 - 15 - 20 - 25 - 27 - 30 - 40
- 1 portainseriti magnetico
- 1 adattatore per bussole 1/4"

CONTENT:

- 4 hex bits 3 - 4 - 5 - 6 mm
- 4 slotted bits 3 - 4 - 5 - 6 mm
- 4 Phillips bits PH1 - 2 - 2 - 3
- 4 Pozidriv bits PZ1 - 2 - 2 - 3
- 7 Torx bits T10 - 15 - 20 - 25 - 27 - 30 - 40
- 7 Torx Security bits T10 - 15 - 20 - 25 - 27 - 30 - 40
- 1 magnetic bit holder
- 1 socket adaptor 1/4"



Espositore 10 pezzi
10-piece display



INSERTI BITS

SET CRICCHETTO CON INSERTI E BUSSOLE 19 PEZZI 19-PIECE SOCKET AND BIT SET WITH RATCHET

In acciaio S2.

Made of S2 steel.

DATI TECNICI / TECHNICAL DATA

ART. E06096

COMPOSIZIONE:

- 4 inserti esagonali 3 - 4 - 5 - 6 mm
- 2 inserti a taglio 4 - 6 mm
- 3 inserti Phillips PH1 - 2 - 3
- 3 inserti Pozidriv PZ1 - 2 - 3
- 5 bussole 6 - 7 - 8 - 10 - 13 mm
- 1 cricchetto 1/4"
- 1 adattatore per bussole 1/4"

CONTENT:

- 4 hex bits 3 - 4 - 5 - 6 mm
- 2 slotted bits 4 - 6 mm
- 3 Phillips bits PH1 - 2 - 3
- 3 Pozidriv bits PZ1 - 2 - 3
- 5 sockets 6 - 7 - 8 - 10 - 13 mm
- 1 ratchet 1/4"
- 1 socket adaptor 1/4"



Espositore 10 pezzi
10-piece display



13

SET INSERTI A BUSSOLA 8 PEZZI 8-PIECE SOCKET BIT SET

In Cromo Vanadio. Attacco 1/4".

Made of Chrome Vanadium. 1/4" drive.

DATI TECNICI / TECHNICAL DATA

ART. E06097

MISURE:

- 8 inserti esagonali 5 - 6 - 7 - 8 - 9 - 10 - 11 - 13 mm

SIZE:

- 8 hex bits 5 - 6 - 7 - 8 - 9 - 10 - 11 - 13 mm



Espositore 10 pezzi
10-piece display



SET INSERTI A BUSSOLA 32 PEZZI 32-PIECE SOCKET BIT SET

In acciaio S2. Attacco 1/2".

Made of S2 steel. 1/2" drive.

DATI TECNICI / TECHNICAL DATA

ART. E05160 E02011

Confezione / Packaging	termoretraibile shrink film	valigetta ABS ABS case
------------------------	--------------------------------	---------------------------

COMPOSIZIONE:

- 8 inserti esagonali da 55 mm 5 - 6 - 7 - 8 - 10 - 12 - 14 - 17 mm
- 8 inserti Torx da 55 mm T25 - 27 - 30 - 40 - 45 - 50 - 55 - 60
- 4 inserti millerighe da 55 mm M5 - 6 - 8 - 10
- 4 inserti esagonali da 100 mm 6 - 8 - 10 - 12 mm
- 4 inserti Torx da 100 mm T30 - 40 - 50 - 60
- 4 inserti millerighe da 100 mm M6 - 8 - 10 - 12

CONTENT:

- 8 hex bits to 55 mm 5 - 6 - 7 - 8 - 10 - 12 - 14 - 17 mm
- 8 Torx bits to 55 mm T25 - 27 - 30 - 40 - 45 - 50 - 55 - 60
- 4 triple square bits to 55 mm M5 - 6 - 8 - 10
- 4 hex bits to 100 mm 6 - 8 - 10 - 12 mm
- 4 Torx bits to 100 mm T30 - 40 - 50 - 60
- 4 triple square bits to 100 mm M6 - 8 - 10 - 12



INSERTI BITS

SET INSERTI CON PORTAININSERTI MAGNETICO BLOCCAVITE BIT SET WITH MAGNETIC BIT HOLDER

In acciaio S2. Il magnete consente il bloccaggio della vite per un facile e veloce avvitarmento.

Made of S2 steel. Magnet holds screw in place in order to screw it faster and better.

Espositore 12 pezzi
12-piece display



DATI TECNICI / TECHNICAL DATA

ART. E06014

COMPOSIZIONE:

- 2 inserti a taglio 4 - 6 mm
- 3 inserti Phillips PH1 - 2 - 2
- 3 inserti Pozidriv PZ1 - 2 - 2
- 1 portaininserti magnetico 1/4" 60 mm

CONTENT:

- 2 slotted bits 4 - 6 mm
- 3 Phillips bits PH1 - 2 - 2
- 3 Pozidriv bits PZ1 - 2 - 2
- 1 magnetic bit holder 1/4" 60 mm

SET INSERTI COLORATI CON PORTAININSERTI 15 PEZZI 15-PIECE COLOR-CODED BIT SET

In acciaio S2.

Made of S2 steel.

Espositore 12 pezzi
12-piece display



DATI TECNICI / TECHNICAL DATA

ART. E06013

COMPOSIZIONE:

- 3 inserti a taglio 3 - 4 - 6 mm
- 3 inserti Phillips PH1 - 2 - 3
- 3 inserti Pozidriv PZ1 - 2 - 3
- 5 inserti Torx Security T10 - 15 - 20 - 25 - 30
- 1 portaininserti magnetico 65 mm

CONTENT:

- 3 slotted bits 3 - 4 - 6 mm
- 3 Phillips bits PH1 - 2 - 3
- 3 Pozidriv bits PZ1 - 2 - 3
- 5 Torx Security bits T10 - 15 - 20 - 25 - 30
- 1 magnetic bit holder 65 mm



INSERTI BITS

SET INSERTI CON PORTAININSERTI MAGNETICO 31 PEZZI 31-PIECE BIT SET WITH MAGNETIC BIT HOLDER

In acciaio S2. Attacco esagonale 1/4". Made of S2 steel. 1/4" hex drive.

DATI TECNICI / TECHNICAL DATA

ART. E05981

COMPOSIZIONE:

- 4 inserti esagonali 3 - 4 - 5 - 6 mm
- 4 inserti a taglio 3 - 4 - 5 - 6 mm
- 4 inserti Phillips PH1 - 2 - 2 - 3
- 4 inserti Pozidriv PZ1 - 2 - 2 - 3
- 7 inserti Torx T10 - 15 - 20 - 25 - 27 - 30 - 40
- 7 inserti Torx Security T10 - 15 - 20 - 25 - 27 - 30 - 40
- 1 portaininserti magnetico

CONTENT:

- 4 hex bits 3 - 4 - 5 - 6 mm
- 4 slotted bits 3 - 4 - 5 - 6 mm
- 4 Phillips bits PH1 - 2 - 2 - 3
- 4 Pozidriv bits PZ1 - 2 - 2 - 3
- 7 Torx bits T10 - 15 - 20 - 25 - 27 - 30 - 40
- 7 Torx Security bits T10 - 15 - 20 - 25 - 27 - 30 - 40
- 1 magnetic bit holder

Confezione: scatola
Packaging: case



SET INSERTI 113 PEZZI 113-PIECE BIT SET

In acciaio S2. Attacco esagonale 1/4". Made of S2 steel. 1/4" hex drive.

DATI TECNICI / TECHNICAL DATA

ART. E05989

COMPOSIZIONE:

- 3 inserti esagonali da 25 mm 4 - 5 - 6 mm (7 pz per misura)
- 2 inserti a taglio da 25 mm 4 - 4,5 mm (7 pz per misura)
- 3 inserti Phillips da 25 mm PH1 - 2 - 3 (7 pz per misura)
- 3 inserti Pozidriv da 25 mm PZ1 - 2 - 3 (7 pz per misura)
- 7 inserti Torx da 25 mm T10 - 15 - 20 - 25 - 27 - 30 - 40 (2 pz per misura)
- 7 inserti Torx Security da 25 mm T10 - 15 - 20 - 25 - 27 - 30 - 40 (2 pz per misura)
- 3 inserti Phillips da 75 mm PH1 - 2 - 3
- 3 inserti Pozidriv da 75 mm PZ1 - 2 - 3
- 7 inserti Torx da 75 mm T10 - 15 - 20 - 25 - 27 - 30 - 40
- 2 portaininserti

CONTENT:

- 3 hex bits 25 mm 4 - 5 - 6 mm (7 pcs each size)
- 2 slotted bits 25 mm 4 - 4,5 mm (7 pcs each size)
- 3 Phillips bits 25 mm PH1 - 2 - 3 (7 pcs each size)
- 3 Pozidriv bits 25 mm PZ1 - 2 - 3 (7 pcs each size)
- 7 Torx bits 25 mm T10 - 15 - 20 - 25 - 27 - 30 - 40 (2 pcs each size)
- 7 Torx Security bits to 25 mm T10 - 15 - 20 - 25 - 27 - 30 - 40 (2 pcs each size)
- 3 Phillips bits 75 mm PH1 - 2 - 3
- 3 Pozidriv bits 75 mm PZ1 - 2 - 3
- 7 Torx bits 75 mm T10 - 15 - 20 - 25 - 27 - 30 - 40
- 2 bit holders

Confezione: scatola ABS
Packaging: ABS case



INSERTI BITS

SET GIRAVITE COMPLETO DI 142 PEZZI SCREWDRIVER SET WITH 142 TOOLS

In Cromo Vanadio.

Made of Chrome Vanadium.

DATI TECNICI / TECHNICAL DATA

ART. E06012

COMPOSIZIONE:

- 9 inserti esagonali da 25 mm 1,5 - 2 - 2,5 - 3 - 4 - 5 - 5,5 - 6 - 8 mm
- 10 inserti esagonali da 25 mm 1/16" - 5/64" - 3/32" - 7/64" - 1/8" - 9/64" - 5/32" - 3/16" - 7/32" - 1/4"
- 6 inserti esagonali forati da 25 mm 2 - 2,5 - 3 - 4 - 5 - 6
- 12 inserti a taglio da 25 mm 2 - 2,5 - 3 - 3,5 - 4 - 4,5 - 5 - 5,5 - 6 - 6,5 - 7 - 8 mm
- 5 inserti Phillips da 25 mm PH00 - 0 - 1 - 2 - 3
- 5 inserti Pozidriv da 25 mm PZ00 - 0 - 1 - 2 - 3
- 13 inserti Torx da 25 mm T5 - 6 - 7 - 8 - 9 - 10 - 15 - 20 - 25 - 27 - 30 - 40 - 45
- 9 inserti Torx Security da 25 mm T8 - 10 - 15 - 20 - 25 - 27 - 30 - 35 - 40
- 4 inserti Robertson da 25 mm 0 - 1 - 2 - 3
- 9 inserti Pentalobe da 25 mm TS10 - 15 - 20 - 25 - 27 - 30 - 40 - 45 - 50
- 3 inserti millerighe da 25 mm M5 - 6 - 8
- 4 inserti Tri-Wing da 25 mm 1 - 2 - 3 - 4
- 3 inserti Torq-Set da 25 mm 6 - 8 - 10
- 3 inserti One Way da 25 mm 1 - 2 - 3
- 4 inserti Spanner da 25 mm 4 - 6 - 8 - 10
- 10 inserti a bussola da 38 mm 4 - 5 - 6 - 7 - 8 - 9 - 10 - 11 - 12 - 13 mm
- 10 inserti a bussola da 38 mm 5/32" - 3/16" - 7/32" - 1/4" - 9/32" - 11/32" - 5/16" - 3/8" - 7/16" - 1/2"
- 2 inserti esagonali da 50 mm 5 - 6 mm
- 2 inserti a taglio da 50 mm 4 - 6,5 mm
- 3 inserti Phillips da 50 mm PH1 - 2 - 3
- 3 inserti Pozidriv da 50 mm PZ1 - 2 - 3
- 7 inserti Torx da 50 mm T10 - 15 - 20 - 25 - 27 - 30 - 40
- 1 portainseri magnetico 1/4" 100 mm
- 1 adattatore per inserti 60 mm
- 2 adattatori per bussole 25 - 50 mm
- 1 inserto a Y

CONTENT:

- 9 hex bits 25 mm 1,5 - 2 - 2,5 - 3 - 4 - 5 - 5,5 - 6 - 8 mm
- 10 hex bits 25 mm 1/16" - 5/64" - 3/32" - 7/64" - 1/8" - 9/64" - 5/32" - 3/16" - 7/32" - 1/4"
- 6 security hex bits 25 mm 2 - 2,5 - 3 - 4 - 5 - 6
- 12 slotted bits 25 mm 2 - 2,5 - 3 - 3,5 - 4 - 4,5 - 5 - 5,5 - 6 - 6,5 - 7 - 8 mm
- 5 Phillips bits 25 mm PH00 - 0 - 1 - 2 - 3
- 5 Pozidriv bits 25 mm PZ00 - 0 - 1 - 2 - 3
- 13 Torx bits 25 mm T5 - 6 - 7 - 8 - 9 - 10 - 15 - 20 - 25 - 27 - 30 - 40 - 45
- 9 Torx Security bits 25 mm T8 - 10 - 15 - 20 - 25 - 27 - 30 - 35 - 40
- 4 Robertson bits 25 mm 0 - 1 - 2 - 3
- 9 Pentalobe bits 25 mm TS10 - 15 - 20 - 25 - 27 - 30 - 40 - 45 - 50
- 3 Triple square bits 25 mm M5 - 6 - 8
- 4 Tri-Wing bits 25 mm 1 - 2 - 3 - 4
- 3 Torq-Set bits 25 mm 6 - 8 - 10
- 3 One Way bits 25 mm 1 - 2 - 3
- 4 Spanner bits 25 mm 4 - 6 - 8 - 10
- 10 socket bits 38 mm 4 - 5 - 6 - 7 - 8 - 9 - 10 - 11 - 12 - 13 mm
- 10 socket bits 38 mm 5/32" - 3/16" - 7/32" - 1/4" - 9/32" - 11/32" - 5/16" - 3/8" - 7/16" - 1/2"
- 2 hex bits 50 mm 5 - 6 mm
- 2 slotted bits 50 mm 4 - 6,5 mm
- 3 Phillips bits 50 mm PH1 - 2 - 3
- 3 Pozidriv bits 50 mm PZ1 - 2 - 3
- 7 Torx bit 50 mm T10 - 15 - 20 - 25 - 27 - 30 - 40
- 1 magnetic bit holder 1/4" 100 mm
- 1 bit adaptor 60 mm
- 2 socket adaptors 25 - 50 mm
- 1 wing nut driver

Confezione: valigetta ABS
Packaging: ABS case



GIRAVITI SCREWDRIVERS

GIRAVITI PHILLIPS / PHILLIPS SCREWDRIVERS

Impugnatura ergonomica in bicomponente. Lama in acciaio S2 e punta temperata.

Bi-material ergonomic handle. S2 steel blade and hardened tip.

DATI TECNICI / TECHNICAL DATA

ART.	E07163	E07164	E07165	E07166	E07167
Misura / Size PH x mm	0x60	1x80	1x150	1x200	2x100
ART.	E07168	E07169	E07170	E07171	
Misura / Size PH x mm	2x150	2x200	3x150	4x200	



GIRAVITI A TAGLIO / SLOTTED SCREWDRIVERS

Impugnatura ergonomica in bicomponente. Lama in acciaio S2 e punta temperata.

Bi-material ergonomic handle. S2 steel blade and hardened tip.

DATI TECNICI / TECHNICAL DATA

ART.	E07151	E07152	E07153	E07154
Misura / Size mm	3x100	4x100	5,5x100	5,5x125
ART.	E07155	E07156	E07157	E07158
Misura / Size mm	6,5x150	8x175	10x200	12x250



GIRAVITI POZIDRIV / POZIDRIV SCREWDRIVERS

Impugnatura ergonomica in bicomponente. Lama in acciaio S2 e punta temperata.

Bi-material ergonomic handle. S2 steel blade and hardened tip.

DATI TECNICI / TECHNICAL DATA

ART.	E07175	E07176	E07177	E07178	E07179
Misura / Size PZ x mm	0x60	1x80	2x100	2x150	3x150



GIRAVITI TORX SECURITY TORX SECURITY SCREWDRIVERS

Impugnatura ergonomica in bicomponente. Lama in acciaio S2 e punta temperata.

Bi-material ergonomic handle. S2 steel blade and hardened tip.

DATI TECNICI / TECHNICAL DATA

ART.	E07180	E07181	E07182	E07183	E07184	E07185
Misura / Size T x mm	7x60	8x60	9x60	10x80	15x80	20x100
ART.	E07186	E07187	E07188	E07189	E07190	
Misura / Size T x mm	25x100	27x115	30x115	40x130	45x130	



GIRAVITI ESAGONALI / HEX SCREWDRIVERS

Impugnatura ergonomica in bicomponente. Lama in acciaio S2 e punta temperata.

Bi-material ergonomic handle. S2 steel blade and hardened tip.

DATI TECNICI / TECHNICAL DATA

ART.	E07191	E07192	E07193	E07194
Misura / Size mm	2x75	2,5x75	3x75	4x75
ART.	E07195	E07196	E07197	E07198
Misura / Size mm	5x75	6x100	8x100	10x100



GIRAVITI SCREWDRIVERS

GIRAVITI A TAGLIO EXTRALUNGHI EXTRA LONG SLOTTED SCREWDRIVERS

Impugnatura ergonomica in bicomponente. Lama in acciaio S2 e punta temperata. Bi-material ergonomic handle. S2 steel blade and hardened tip.

DATI TECNICI / TECHNICAL DATA					
ART.		E07159	E07160	E07161	E07162
Misura / Size	mm	2,5x200	3x300	4x400	5,5x400

GIRAVITI PHILLIPS EXTRALUNGHI EXTRA LONG PHILLIPS SCREWDRIVERS

Impugnatura ergonomica in bicomponente. Lama in acciaio S2 e punta temperata. Bi-material ergonomic handle. S2 steel blade and hardened tip.

DATI TECNICI / TECHNICAL DATA			
ART.		E07172	E07173
Misura / Size	PH x mm	0x300	1x400

GIRAVITI PHILLIPS NANI STUBBY PHILLIPS SCREWDRIVERS

Impugnatura ergonomica in bicomponente. Lama in acciaio S2 e punta temperata. Bi-material ergonomic handle. S2 steel blade and hardened tip.

DATI TECNICI / TECHNICAL DATA			
ART.		E07222	E07223
Misura / Size	PH x mm	1x25	2x25

GIRAVITI POZIDRIV NANI STUBBY POZIDRIV SCREWDRIVERS

Impugnatura ergonomica in bicomponente. Lama in acciaio S2 e punta temperata. Bi-material ergonomic handle. S2 steel blade and hardened tip.

DATI TECNICI / TECHNICAL DATA			
ART.		E07224	E07225
Misura / Size	PZ x mm	1x25	2x25

GIRAVITI A TAGLIO NANI STUBBY SLOTTED SCREWDRIVERS

Impugnatura ergonomica in bicomponente. Lama in acciaio S2 e punta temperata. Bi-material ergonomic handle. S2 steel blade and hardened tip.

DATI TECNICI / TECHNICAL DATA			
ART.		E07220	E07221
Misura / Size	mm	5,5x25	6,5x25

GIRAVITI A BUSSOLA FLESSIBILI FLEXIBLE SOCKET SCREWDRIVERS

Impugnatura ergonomica in bicomponente. Lama in acciaio Cromo Vanadio. Bi-material ergonomic handle. Chrome Vanadium steel blade.

DATI TECNICI / TECHNICAL DATA				
ART.		E07123	E07124	E07125
Misura / Size	mm	6	7	8



GIRAVITI SCREWDRIVERS

GIRAVITI A BUSSOLA / SOCKET SCREWDRIVERS

Impugnatura ergonomica in bicomponente. Lama in acciaio Cromo Vanadio.

Bi-material ergonomic handle. Chrome Vanadium steel blade.

DATI TECNICI / TECHNICAL DATA

ART.	E07111	E07112	E07113	E07114
Misura / Size	mm 3	4	5	6
ART.	E07115	E07116	E07117	E07118
Misura / Size	mm 7	8	9	10
ART.	E07119	E07121	E07122	
Misura / Size	mm 11	12	13	



GIRAVITE A BUSSOLA FLESSIBILE FLEXIBLE SOCKET SCREWDRIVER

Impugnatura ergonomica in bicomponente. Lama in acciaio Cromo Vanadio.

Bi-material ergonomic handle. Chrome Vanadium steel blade.

DATI TECNICI / TECHNICAL DATA

ART.	E07126
Misura / Size	1/4" - 5/16"

GIRAVITE PORTAINSERTI / SCREWDRIVER BIT HOLDER

Impugnatura ergonomica in bicomponente. Lama in acciaio Inox.

Bi-material ergonomic handle. Made of stainless steel.

DATI TECNICI / TECHNICAL DATA

ART.	E07127
Misura / Size	mm 1/4"x100

GIRAVITE PORTAINSERTI A BAIONETTA BAYONET SCREWDRIVER BIT HOLDER

Impugnatura ergonomica in bicomponente. Lama in acciaio Cromo Vanadio.

Bi-material ergonomic handle. Chrome Vanadium steel blade.

DATI TECNICI / TECHNICAL DATA

ART.	E07128
Misura / Size	mm 1/4"x100



GIRAVITI PHILLIPS TESTA BATTENTE POUND-THROUGH PHILLIPS SCREWDRIVERS

In acciaio S2 con impugnatura in bicomponente antiscivolo e lama passante.

Made of S2 steel with anti-slip bi-material handle and through blade.

DATI TECNICI / TECHNICAL DATA

ART.	E07106	E07107	E07108	E07109	E07110
Misura / Size PH x mm	0x75	1x100	2x100	3x150	4x200



GIRAVITI SCREWDRIVERS

GIRAVITI A TAGLIO TESTA BATTENTE POUND-THROUGH SLOTTED SCREWDRIVERS

In acciaio S2 con impugnatura in bicomponente antiscivolo e lama passante.

Made of S2 steel with anti-slip bi-material handle and through blade.

DATI TECNICI / TECHNICAL DATA

ART.	E07100	E07101	E07102	E07103	E07104
Misura / Size PH x mm	3x75	5x100	6x100	8x150	9,5x200



GIRAVITI TORX SECURITY TESTA BATTENTE POUND-THROUGH TORX SECURITY SCREWDRIVERS

In acciaio S2 con impugnatura in bicomponente antiscivolo e lama passante.

Made of S2 steel with anti-slip bi-material handle and through blade.

DATI TECNICI / TECHNICAL DATA

ART.	E07130	E07131	E07133
Misura / Size T	9	10	20
ART.	E07134	E07135	
Misura / Size T	25	30	



GIRAVITI A BUSSOLA TESTA BATTENTE POUND-THROUGH SOCKET SCREWDRIVERS

In acciaio S2 con impugnatura in bicomponente antiscivolo e lama passante.

Made of S2 steel with anti-slip bi-material handle and through blade.

DATI TECNICI / TECHNICAL DATA

ART.	E07140	E07143	E07144	E07145
Misura / Size mm	6x150	12x150	13x150	14x150



GIRAVITE NANO A TAGLIO TESTA BATTENTE POUND-THROUGH SLOTTED STUBBY SCREWDRIVER

In acciaio S2 con impugnatura in bicomponente antiscivolo e lama passante.

Made of S2 steel with anti-slip bi-material handle and through blade.

DATI TECNICI / TECHNICAL DATA

ART.	E08550
Misura / Size mm	2x38



GIRAVITE NANO PHILLIPS TESTA BATTENTE POUND-THROUGH PHILLIPS STUBBY SCREWDRIVER

In acciaio S2 con impugnatura in bicomponente antiscivolo e lama passante.

Made of S2 steel with anti-slip bi-material handle and through blade.

DATI TECNICI / TECHNICAL DATA

ART.	E08540
Misura / Size PHxmm	2x38



GIRAVITI SCREWDRIVERS

GIRAVITI ISOLATI PHILLIPS 1000 V INSULATED PHILLIPS SCREWDRIVERS 1000 V

In acciaio S2.

Made of S2 steel.

DATI TECNICI / TECHNICAL DATA

ART.	E07237	E07238	E07239	E07240
Misura / Size PHxmm	0x60	1x80	2x100	3x150



GIRAVITI ISOLATI A TAGLIO 1000 V INSULATED SLOTTED SCREWDRIVERS 1000 V

In acciaio S2.

Made of S2 steel.

DATI TECNICI / TECHNICAL DATA

ART.	E07230	E07231	E07232	E07233
Misura / Size mm	2,5x75	3x100	3,5x100	4x100

ART.	E07234	E07235	E07236
Misura / Size mm	5,5x125	6,5x150	8x175



GIRAVITI ISOLATI POZIDRIV 1000 V INSULATED POZIDRIV SCREWDRIVERS 1000 V

In acciaio S2.

Made of S2 steel.

DATI TECNICI / TECHNICAL DATA

ART.	E07241	E07242	E07243	E07244
Misura / Size PZ x mm	0x60	1x80	2x100	3x150



SET 8 GIRAVITI TAGLIO E PHILLIPS 8-PIECE SLOTTED AND PHILLIPS SCREWDRIVER SET

In acciaio S2.

Made of S2 steel.

DATI TECNICI / TECHNICAL DATA

ART.	E07139	E02000
Confezione / Packaging	termoretraibile shrink film	valigetta ABS ABS case

COMPOSIZIONE:

- 4 giraviti a taglio 3x75 - 4x100 - 5,5x125 - 6,5x150 mm
- 4 giraviti Phillips PH0x60 - 1x80 - 2x100 - 2x150

CONTENT:

- 4 slotted screwdrivers 3x75 - 4x100 - 5,5x125 - 6,5x150 mm
- 4 Phillips screwdrivers PH0x60 - 1x80 - 2x100 - 2x150



SET 8 GIRAVITI TORX SECURITY 8-PIECE TORX SECURITY SCREWDRIVER SET

In acciaio S2.

Made of S2 steel.

DATI TECNICI / TECHNICAL DATA

ART.	E07246	E02001
Confezione / Packaging	termoretraibile shrink film	valigetta ABS ABS case
Misura / Size	T	10 - 15 - 20 - 25 - 27 - 30 - 40 - 45



GIRAVITI SCREWDRIVERS

SET 8 GIRAVITI ESAGONALI 8-PIECE HEX SCREWDRIVER SET

In acciaio S2.

Made of S2 steel.

DATI TECNICI / TECHNICAL DATA		
ART.	E07247	E02002
Confezione / Packaging	termoretraibile shrink film	valigetta ABS ABS case
Misura / Size	mm	2 - 2,5 - 3 - 4 - 5 - 6 - 8 - 10



SET 7 GIRAVITI A BUSSOLA 7-PIECE SOCKET SCREWDRIVER SET

In acciaio Cromo Vanadio.

Made of Chrome Vanadium.

DATI TECNICI / TECHNICAL DATA		
ART.	E07248	E02003
Confezione / Packaging	termoretraibile shrink film	valigetta ABS ABS case
Misura / Size	mm	5 - 6 - 7 - 8 - 9 - 10 - 13



SET 8 GIRAVITI ISOLATI 1000 V 8-PIECE 1000 V INSULATED SCREWDRIVER SET

In acciaio S2.

Made of S2 steel.

DATI TECNICI / TECHNICAL DATA		
ART.	E07249	E02004
Confezione / Packaging	termoretraibile shrink film	valigetta ABS ABS case

COMPOSIZIONE:

- 4 giraviti a taglio 3 - 4 - 5,5 - 6,5 mm
- 4 giraviti Phillips PH0 - 1 - 2 - 3

CONTENT:

- 4 slotted screwdrivers 3 - 4 - 5,5 - 6,5 mm
- 4 Phillips screwdrivers PH0 - 1 - 2 - 3



KIT UTENSILI PER ELETTRICISTI / ELECTRICIAN TOOL KIT

In Cromo Vanadio, isolamento 1000 V

Made of Chrome Vanadium, insulation 1000 V

DATI TECNICI / TECHNICAL DATA	
ART.	E09058

COMPOSIZIONE:

- 1 pinza isolata 180 mm
- 1 pinza becchi mezzi tondi 160 mm
- 1 forbice da elettricista 145 mm
- 2 giraviti a taglio 5,5x125 - 6,5x150 mm
- 2 giraviti Phillips PH1x75 - 2x100 mm
- 1 chiave universale a 4 vie

CONTENT:

- 1 pliers 180 mm
- 1 half-round pliers 160 mm
- 1 electrician shears 145 mm
- 2 slotted screwdrivers 5,5x125 - 6,5x150 mm
- 2 Phillips screwdrivers PH1x75 - 2x100 mm
- 1 multi-purpose 4-way key

Confezione: valigetta ABS / Packaging: ABS case



GIRAVITI SCREWDRIVERS

SET GIRAVITI – SERIE S – SCREWDRIVER SET – S SERIES –

ART. S30106

Composizione n° 6 pezzi: / Content n° 6 pieces:

pz / pcs	1	1	1	1	1	1
	meccanico / mechanic		elettricista / electrician		Phillips	
mm	5,5x125	6,5x150	3,0x75	4,0x100	PH1x75	PH2x100

ART. S30107

Composizione n° 7 pezzi: / Content n° 7 pieces:

pz / pcs	1	1	1	1	1	1	1
	meccanico / mechanic		elettricista / electrician			Phillips	
mm	6,5x125	8,0x150	3,0x75	4,0x100	5,5x150	PH1x80	PH2x100

ART. S50108

Composizione n° 8 pezzi: / Content n° 8 pieces:

pz / pcs	1	1	1	1	1	1	1	1
	meccanico / mechanic			elettricista / electrician		Phillips		
mm	5,5x100	6,5x125	8,0x150	6,5x25		PH0x75	PH1x75	PH2x25 PH2x100

ART. S53005

Composizione n° 5 pezzi: / Content n° 5 pieces:

pz / pcs	1	1	1	1	1
	Torx				
mm	T10x75	T20x100	T25x125	T30x150	T40x150

ART. S55005

Composizione n° 5 pezzi: / Content n° 5 pieces:

pz / pcs	1	1	1	1	1
	Torx con foro / Torx with hole				
mm	T10x75	T20x100	T25x125	T30x150	T40x150



SET GIRAVITI DI PRECISIONE 58/60 HRC PRECISION SCREWDRIVER SET 58/60 HRC

Con magnetizzatore e smagnetizzatore. With magnetizer and demagnetizer.

ART. S02106

Composizione n° 6 pezzi: / Content n° 6 pieces:

pz / pcs	1	1	1	1	1	1
	meccanico / mechanic			Phillips		
mm	1,5x50	2,0x50	3,0x50	PH00x50	PH0x50	PH1x50



SET LAME CON GIRAVITE A BLOCCAGGIO DI ALTA PRECISIONE 58/60 HRC BLADES SET WITH HIGH-PRECISION CLAMPING SCREWDRIVER 58/60 HRC

Con magnetizzatore e smagnetizzatore. With magnetizer and demagnetizer.

ART. S14108

Composizione n° 14 lame + n°1 giravite: / Content n° 14 blades + n° 1 screwdriver

pz / pcs	1	1	1	1	1	1	1
	meccanico / mechanic			Phillips			Torx
mm	2,0x50	3,0x50	4,0x50	PH00x50	PH0x50	PH1x50	T5x50
pz / pcs	1	1	1	1	1	1	1
	Torx					esagonale / hexagonal	
mm	T6x50	T7x50	T8x50	T9x50	T10x50	1,5x50	2,0x50



GIRAVITI SCREWDRIVERS

SET 5 GIRAVITI LUNGI TESTA BATTENTE 5-PIECE POUND-THROUGH LONG SCREWDRIVER SET

In acciaio 8660 con impugnatura in TPR e lama passante.

Made of 8660 steel, TPR handle and through blade.

DATI TECNICI / TECHNICAL DATA

ART. E07226

COMPOSIZIONE:

- 2 giraviti a taglio 8x200 - 8x305 mm
- 3 giraviti Phillips PH2x200 - 2x305 - 2x450 mm

CONTENT:

- 2 slotted screwdrivers 8x200 - 8x305 mm
- 3 Phillips screwdrivers PH2x200 - 2x305 - 2x450 mm

Confezione: doppio blister / Packaging: double blister



SET 3 GIRAVITI FLESSIBILI CON INSERTI 3-PIECE FLEXIBLE SCREWDRIVER SET WITH BITS

Attacco 1/4"

1/4" drive

DATI TECNICI / TECHNICAL DATA

ART. K50043

COMPOSIZIONE:

- 3 bussole 5 - 6 - 8 mm
- 2 inserti a taglio 5,5 - 6,5 mm
- 2 inserti Phillips PH1 - 2
- 5 inserti Torx T10 - 15 - 20 - 25 - 27

CONTENT:

- 3 sockets 5 - 6 - 8 mm
- 2 slotted bits 5,5 - 6,5 mm
- 2 Phillips bits PH1 - 2
- 5 Torx bits T10 - 15 - 20 - 25 - 27

Confezione: blister / Packaging: blister



GIRAVITE A CRICCHETTO CON 12 INSERTI RATCHETING SCREWDRIVER WITH 12 BITS

In Cromo Vanadio attacco 1/4" con impugnatura in bicomponente.

Made of Chrome Vanadium with bi-material handle 1/4" drive.

DATI TECNICI / TECHNICAL DATA

ART. E07120

COMPOSIZIONE:

- 3 inserti esagonali da 25 mm 4 - 5 - 6 mm
- 2 inserti a taglio da 25 mm 5,5 - 6,5 mm
- 2 inserti Phillips da 25 mm PH1 - 2
- 2 inserti Pozidriv da 25 mm PZ1 - 2
- 3 inserti Torx da 25 mm T15 - 20 - 25
- 1 portainseriti 50 mm

CONTENT:

- 3 hex bits 25 mm 4 - 5 - 6 mm
- 2 slotted bits 25 mm 5,5 - 6,5 mm
- 2 Phillips bits 25 mm PH1 - 2
- 2 Pozidriv bits 25 mm PZ1 - 2
- 3 Torx bits 25 mm T15 - 20 - 25
- 1 bit holder 50 mm



Espositore 12 pezzi
12-piece display



GIRAVITI SCREWDRIVERS

SET GIRAVITE A CRICCHETTO 10 IN 1 MULTI-BIT RATCHETING SCREWDRIVER WITH 10 BITS

In Cromo Vanadio con impugnatura in ABS.

Made of Chrome Vanadium with ABS handle.



Espositore 24 pezzi
24-piece display



DATI TECNICI / TECHNICAL DATA

ART. E07015

COMPOSIZIONE:

- 3 inserti a taglio da 30 mm 1,5 - 2 - 3 mm
- 3 inserti Phillips da 30 mm PH00 - 0 - 1
- 4 inserti Torx da 30 mm T5 - 6 - 8 - 10

CONTENT:

- 3 slotted bits 30 mm 1,5 - 2 - 3 mm
- 3 Phillips bits 30 mm PH00 - 0 - 1
- 4 Torx bits 30 mm T5 - 6 - 8 - 10

GIRAVITE A CRICCHETTO RATCHET SCREWDRIVER

Bloccaggio sinistro/destro. Adattatore per bits.
10 bits ad alta resistenza.

Left/right locking. Bit adapter.
10 high strength bits.



ART. 89315.702

Composizione: / Content:

pz / pcs	1	1	1	1	1
	meccanico / mechanic			Phillips	
mm	4,0x25	5,0x25	6,0x25	PH1x25	PH2x25
pz / pcs	1	1	1	1	1
	Pozidriv			Torx	
mm	PZ1x25	PZ2x25	T10x25	T15x25	T20x25



CHIAVE UNIVERSALE A 4 VIE MULTI-PURPOSE 4-WAY KEY

In Cromo Vanadio con un inserto a taglio e uno Phillips.

Made of Chrome Vanadium with one slotted bit and one Phillips bit.



ART. E05150

Confezione: doppio blister / Packaging: double blister

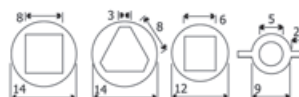

PINZE PLIERS

PINZE UNIVERSALI / UNIVERSAL PLIERS

In acciaio al Cromo Molibdeno, taglienti ad alta resistenza e manici in bicomponente.

Made of Chrome Molibdenum steel, high-resistance jaws and bi-material handles.

DATI TECNICI / TECHNICAL DATA

ART.	E93006	E93001	E93007	
Misura / Size	mm	160	175	200



PINZA BECCHI MEZZI TONDI / HALF-ROUND JAW PLIERS

In acciaio al Cromo Molibdeno, taglienti ad alta resistenza e manici in bicomponente.

Made of Chrome Molibdenum steel, high-resistance jaws and bi-material handles.

DATI TECNICI / TECHNICAL DATA

ART.	E93003	
Misura / Size	mm	160



TRONCHESE / DIAGONAL CUTTERS

In acciaio al Cromo Molibdeno, taglienti ad alta resistenza e manici in bicomponente.

Made of Chrome Molibdenum steel, high-resistance jaws and bi-material handles.

DATI TECNICI / TECHNICAL DATA

ART.	E93002	
Misura / Size	mm	160



PINZA PER ANELLI ESTERNI / EXTERNAL CIRCLIP PLIERS

In acciaio al Cromo Molibdeno temprato, finitura brunita e superficie di presa zigrinata.

Made of hardened Chrome Molibdenum steel, black oxide finish, knurled grip.

DATI TECNICI / TECHNICAL DATA

ART.	04162	
Misura / Size	mm	170



PINZA PER ANELLI ESTERNI PIEGATI EXTERNAL BENT CIRCLIP PLIERS

In acciaio al Cromo Molibdeno temprato, finitura brunita e superficie di presa zigrinata.

Made of hardened Chrome Molibdenum steel, black oxide finish, knurled grip.

DATI TECNICI / TECHNICAL DATA

ART.	04165	
Misura / Size	mm	160



PINZA PER ANELLI INTERNI / INTERNAL CIRCLIP PLIERS

In Acciaio al Cromo Molibdeno temprato, finitura brunita e superficie di presa zigrinata.

Made of hardened Chrome Molibdenum steel, black oxide finish, knurled grip.

DATI TECNICI / TECHNICAL DATA

ART.	04168	
Misura / Size	mm	170



PINZE PLIERS

PINZA PER ANELLI INTERNI PIEGATI INTERNAL BENT CIRCLIP PLIERS

In acciaio al Cromo Molibdeno temprato, finitura brunita e superficie di presa zigrinata.

Made of hardened Chrome Molibdenum steel, black oxide finish, knurled grip.

DATI TECNICI / TECHNICAL DATA

ART. **04171**

Misura / Size mm 160



SET 3 PINZE 3-PIECE PLIERS SET

In acciaio al Cromo Molibdeno.

Made of harde Chrome Molibdenum steel.

DATI TECNICI / TECHNICAL DATA

ART. **E93044** **E02021**

Confezione / Packaging termoretraibile shrink film valigetta ABS ABS case

COMPOSIZIONE:

- 1 pinza universale 175 mm
- 1 tronchese 160 mm
- 1 pinza becchi mezzi tondi 160 mm

CONTENT:

- 1 universal pliers 175 mm
- 1 diagonal cutter 160 mm
- 1 half round jaw pliers 160 mm



SET 4 PINZE PER ANELLI 4-PIECE CIRCLIP PLIERS SET

In acciaio al Cromo Molibdeno temprato, finitura brunita e superficie di presa zigrinata.

Made of hardened Chrome Molibdenum steel, black oxide finish, knurled grip

DATI TECNICI / TECHNICAL DATA

ART. **E05151** **E02007**

Confezione / Packaging termoretraibile shrink film valigetta ABS ABS case



SET 3 PINZE MANICI LUNGHI 3-PIECE LONG REACH PLIERS SET

In Cromo Molibdeno con impugnatura rivestita antiscivolo.

Made of Chrome Molibdenum steel with anti-slip handle.

DATI TECNICI / TECHNICAL DATA

ART. **E93005** **E02026**

Confezione / Packaging termoretraibile shrink film valigetta ABS ABS case

COMPOSIZIONE:

- 1 pinza piegata 90° 270 mm
- 1 pinza piegata 45° 290 mm
- 1 pinza becchi dritti 300 mm

CONTENT:

- 1 90° bent pliers 270 mm
- 1 45° bent pliers 290 mm
- 1 straight jaw pliers 300 mm



PINZE PLIERS

SET 3 PINZE FLESSIBILI / 3-PIECE FLEXIBLE PLIERS SET

In Cromo Vanadio.

Made of Chrome Vanadium.

DATI TECNICI / TECHNICAL DATA

ART. **K50045**

COMPOSIZIONE:

- 1 pinza universale 180 mm
- 1 tronchese taglio diagonale 160 mm
- 1 pinza becchi mezzi tondi 150 mm

CONTENT:

- 1 universal pliers 180 mm
- 1 diagonal cutter 160 mm
- 1 half round jaw pliers 150 mm

Confezione: scatola / Packaging: box



UTENSILI PER IDRAULICA PIPE TOOLS

GIRATUBI TIPO SVEDESE SWEDISH PATTERN PIPE WRENCHES

In Cromo Vanadio con ganasce piegate a 45°.

Made of Chrome Vanadium with 45° curved jaws.

DATI TECNICI / TECHNICAL DATA

ART.	Tubi / Pipes	Lunghezza / Length
	inch	mm
05201	1/2"	250
05202	1"	320
05203	1 1/2"	400
05204	2"	520



GIRATUBI TIPO SVEDESE SWEDISH PATTERN PIPE WRENCHES

In Cromo Vanadio con ganasce piegate a 90°.

Made of Chrome Vanadium with 90° curved jaws.

DATI TECNICI / TECHNICAL DATA

ART.	Tubi / Pipes	Lunghezza / Length
	inch	mm
05208	1"	300
05209	1 1/2"	410
05210	2"	520



GIRATUBI TIPO STILLSON / STILLSON WRENCHES

Ganasce in acciaio temprato ad induzione, corpo in ghisa forgiata e struttura ad alta resistenza. Durezza denti: 55 HRC.

Inducted hardened jaws, cast iron frame and heavy duty tool. Jaw hardness: 55 HRC

DATI TECNICI / TECHNICAL DATA

ART.	Tubi / Pipes	Lunghezza / Length
	inch	inch
E86004	1 1/2"	10"
E86005	2"	12"
E86006	2"	14"
E86007	2 1/2"	18"
E86008	3"	24"
E86009	5"	36"



UTENSILI PER IDRAULICA PIPE TOOLS

GIRATUBI A RULLINO / ADJUSTABLE PIPE WRENCHES

In Cromo Vanadio, ganasce in acciaio temprato ad induzione. Verniciatura nera.

Made of Chrome Vanadium, inducted hardened steel jaws. Black finish.

DATI TECNICI / TECHNICAL DATA

ART.	Tubi / Pipes	Lunghezza / Length
	inch	mm
05211	1"	175
05212	1 1/2"	230
05213	2"	265
05214	2" 1/2"	300



GIRATUBI A CATENA / CHAIN PIPE WRENCH

In Cromo Vanadio. Per tubi fino a 4".

Made of Chrome Vanadium. For pipes up to 4".

DATI TECNICI / TECHNICAL DATA

ART.	Tipo / Type	Misura / Size
		mm
E86094	giratubo / wrench	300
E86096	catena / chain	



GIRATUBI A NASTRO / STRAP WRENCH

Corpo in plastica. Per tubi fino a 4".

Plastic body. For pipes up to 4".

DATI TECNICI / TECHNICAL DATA

ART.	Misura / Size
	mm
05222	100



CHIAVI A RULLINO / ADJUSTABLE WRENCHES

DATI TECNICI / TECHNICAL DATA

ART.	Lunghezza / Length
	inch / mm
E06120	6" - 150
E06121	8" - 200
E06122	10" - 250
E06123	12" - 300



PINZA AUTOBLOCCANTE / LOCKING PLIERS

In Cromo Vanadio, con ganasce concave.

Made of Chrome Vanadium, with curved jaws.

DATI TECNICI / TECHNICAL DATA

ART.	Lunghezza / Length
	mm
04220	250

Confezione: supporto in plastica / Packaging: plastic support



UTENSILI PER IDRAULICA PIPE TOOLS

PINZE POLIGRIP CON PULSANTE POLIGRIP PLIERS WITH PRESS BUTTON

In Cromo Vanadio, impugnatura con doppio isolamento. Durezza corpo: HRC 38°- 48°, durezza ganasce HRC 58°- 62°.

Made of Chrome Vanadium, double insulated handle. Body hardness: HRC 38°- 48°, jaw hardness: HRC 58°- 62°.

DATI TECNICI / TECHNICAL DATA	
ART.	Misura / Size
	mm
E93036	180
E93033	240
E93037	300

Confezione: supporto in plastica / Packaging: plastic support



PINZE POLIGRIP / POLIGRIP PLIERS

In Cromo Vanadio, con taglienti temprati e impugnatura con doppio isolamento.

Made of Chrome Vanadium, with hardened jaws and double insulated handle.

DATI TECNICI / TECHNICAL DATA	
ART.	Misura / Size
	mm
04287	240
04289	300



PINZE PER IDRAULICI / WATERPUMP PLIERS

Pinza a cerniera a 7 posizioni. Verniciata a polvere, acciaio Cromo Vanadio.

7-position groove pliers. Powder coated, Chrome Vanadium steel.

DATI TECNICI / TECHNICAL DATA	
ART.	Misura / Size
	mm
04285	250
04286	300



CESOIA TAGLIATUBI / PIPE CUTTERS

In alluminio per tubi in polietilene fino a 63 mm. Con movimento a cricchetto.

Made of aluminium for polyethylene pipes up to 63 mm. Ratchet action.

ART.
E86023

Confezione: scatola / Packaging: box

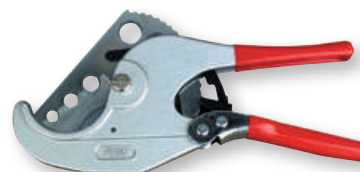

CESOIA TAGLIATUBI / PIPE CUTTERS

In alluminio per tubi in polietilene fino a 35 mm. Con movimento a cricchetto.

Made of aluminium for polyethylene pipes up to 35 mm. Ratchet action.

ART.
K86200

Confezione: scatola / Packaging: box



TAGLIATUBI / PIPE CUTTERS

Corpo in acciaio, rotelle in acciaio temprato. Per tubi fino 2".

Steel body, hardened steel rollers. For pipes up to 2".

DATI TECNICI / TECHNICAL DATA	
ART.	Tipo / Type
E86017	giratubo / wrench
E86018	rotella / roller



UTENSILI PER IDRAULICA PIPE TOOLS

TAGLIATUBI / PIPE CUTTERS

Corpo in acciaio Cromo Vanadio, rotelle in acciaio temprato. Per tubi fino a Ø 42 mm.

Chrome Vanadium steel body, hardened steel rollers. For pipes up to Ø 42 mm.

DATI TECNICI / TECHNICAL DATA

ART.	Tipo / Type
E86019	tagliatubi / pipe cutter
E86020	rotella / roller

Confezione: blister / Packaging: blister



TAGLIATUBI / PIPE CUTTERS

Corpo in acciaio Cromo Vanadio, guida telescopica. Per tubi in rame, acciaio sottile, bronzo, alluminio fino a Ø 32 mm.

Chrome Vanadium steel body, telescopic guide. For copper, thin steel, brass, aluminum pipes up to Ø 32 mm.

DATI TECNICI / TECHNICAL DATA

ART.	Tipo / Type
E86024	tagliatubi / pipe cutter
E86025	rotella / roller

Confezione: blister / Packaging: blister



CESOIA TAGLIATUBI / PIPE CUTTERS

Corpo in acciaio Cromo Vanadio. Per tubi in rame, acciaio sottile, bronzo, alluminio fino a Ø 22 mm.

Chrome Vanadium steel body. For copper, thin steel, brass, aluminium pipes up to Ø 22 mm.

DATI TECNICI / TECHNICAL DATA

ART.	Tipo / Type
E86026	tagliatubi / pipe cutter
E86027	rotella / roller

Confezione: blister / Packaging: blister

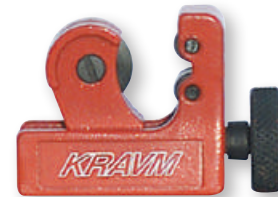

APPARECCHI PER COLLETTI / FLARING TOOLS

Per tubi da 4 a 16 mm (3/16" a 5/8").

For pipes from 4 to 16 mm (3/16" to 5/8").

ART.
K86204

Confezione: blister / Packaging: blister

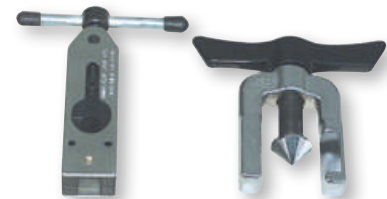

FILIERE PER TUBI / RATCHET THREADERS

DATI TECNICI / TECHNICAL DATA

ART.	Misura / Size inch
E86555	1/4" - 3/8" - 1/2" - 3/4" - 1" - 1 1/4"

Confezione: valigetta / Packaging: case



TREPPIEDE / TRIPOD STAND

ART.
K30570

Confezione: scatola / Packaging: box



MORSETTI E SUPPORTO ESTENSIBILE CLAMPS AND EXTENSIBLE SUPPORTS

MORSETTI RAPIDI TRIGGER CLAMPS

Bloccaggio rapido a pistola. Forte tenuta sul pezzo. Asta in acciaio al carbonio. Corpo in nylon rinforzato con fibra di vetro. Finiture in polietilene morbido.

Quick release trigger. High clamping strength. Carbon steel thrust rod. Nylon body hardened with fiberglass. Soft polyethylene finish.

DATI TECNICI / TECHNICAL DATA	
ART.	Capacità / Capacity inch / mm
E93067	6" - 150
E93068	12" - 300
E93069	18" - 450



SUPPORTI ESTENSIBILI CON STRETTOIA EXTENSIBLE SUPPORTS WITH QUICK CLAMP

Per sostenere strutture, verticalizzare pannelli e porte, stringere oggetti (max 60 cm). Portata max 50 kg.

To support structures, to arrange vertically panels and doors, clamp objects (max 60 cm). Max load capacity 50 kg.

DATI TECNICI / TECHNICAL DATA	
ART.	Estensione / Extension cm
E93065	60÷163
E93066	100÷310



UTENSILI DA TAGLIO CUTTING TOOLS

TAGLIACAVI CABLE CUTTERS

In Cromo Molibdeno, a cerniera sovrapposta.

Made of Chrome Molibdenum, shear type.

DATI TECNICI / TECHNICAL DATA	
ART.	Misura / Size mm
11129	800

Confezione: scatola / Packaging: box



TRONCHESE PER CAVI WIRE CUTTERS

DATI TECNICI / TECHNICAL DATA		
ART.	Ø	Lunghezza / Length
	inch	mm
11130	3/16"	180



CESOIA RODITRICE SHEET METAL NIBBLER

In acciaio speciale con manici isolati.

Made of special steel with insulated handles.

DATI TECNICI / TECHNICAL DATA	
ART.	Tipo / Type
20094	cesoia / nibbler
20095	lama / blade



UTENSILI DA TAGLIO CUTTING TOOLS

TRONCABULLONI BOLT CUTTERS

In Cromo Molibdeno, a cerniera sovrapposta con lame zigrinate.

Made of Chrome Molibdenum, shear type with milled blades.

DATI TECNICI / TECHNICAL DATA

ART.	Misura / Size
	mm
E11002	300
E11003	350
E11004	450
E11005	600
E11006	750
E11007	900

LAME DI RICAMBIO / SPARE BLADES

ART.	Misura / Size
	mm
E11013	350
E11014	450
E11015	600
E11016	750
E11017	900



TRONCABULLONI BOLT CUTTERS

In Cromo Vanadio con bloccaggio in chiusura.

Made of Chrome Vanadium, locks when closing.

DATI TECNICI / TECHNICAL DATA

ART.	Lunghezza / Length
	mm
11100	200

Confezione: tasca in plastica / Packaging: plastic case



TENAGLIA CEMENTISTA / END NIPPERS

In Cromo Vanadio con taglienti temprati e impugnatura con doppio isolamento.

Made of Chrome Vanadium, with hardened jaws and double insulated handle.

DATI TECNICI / TECHNICAL DATA

ART.	Lunghezza / Length
	mm
04411	220



SCALPELLI DA MECCANICA / FLAT COLD CHISELS

DATI TECNICI / TECHNICAL DATA

ART.	Misura / Size
	mm
15421	150
15422	200
15423	250
15424	300



CESOIE PER LAMIERA / SHEET METAL SHEARS

In Cromo Molibdeno e manici bicomponente.

Made of Chrome Molibdenum, bi-material handle.

DATI TECNICI / TECHNICAL DATA

ART.	Taglio / Cut
E86039	destra / right
E86040	sinistra / left



CESOIE / SHEARS

Lame in acciaio forgiato. Lega al Cromo Molibdeno di alta resistenza. Durezza 60-65 HRC. Impugnatura ergonomica in bicomponente.

Drop forged steel blade. High strength Chrome Molibdenum alloy. Hardness 60-65 HRC. Bi-material ergonomic handle.

DATI TECNICI / TECHNICAL DATA

ART.	Taglio / Cut
E86050	dritto / straight
E86051	destra / right
E86052	sinistra / left



UTENSILI DA TAGLIO CUTTING TOOLS

FORBICI PER LAMIERA / SHEET METAL SHEARS

DATI TECNICI / TECHNICAL DATA	
ART.	Lunghezza / Length
	mm
20155	200
20156	260
20157	300



CESOIE TIPO ITALIA / SHEARS

In Cromo Vanadio.

Made of Chrome Vanadium.

DATI TECNICI / TECHNICAL DATA	
ART.	Misura / Size
	mm
20150	220
20151	240
20152	260
20153	280
20154	300



PINZA SCANTONATRICE / HAND NOTCHER

Adatta per giunzioni di canali e bocchette.

Suitable to construct and install sheet metal duct work.

DATI TECNICI / TECHNICAL DATA			
ART.	Triangolo Cut	Profondità gola Cut depth	Lunghezza Length
		mm	mm
E87102	30°	21	220



PINZA PER RIBADIRE A DOPPIA LEVA SNAP LOCK PUNCH WITH DOUBLE LEVER

DATI TECNICI / TECHNICAL DATA			
ART.	Larghezza aperture Jaw width	Altezza aperture Jaw height	Lunghezza Length
	mm	mm	mm
E87103	6	3	200



FORBICE PER ELETTRICISTA ELECTRICIANS SCISSORS

In acciaio inox, manici in bicomponente nylon e santoprene, lame zigrinate.

Made of stainless steel, nylon and santoprene handles, milled blades.

DATI TECNICI / TECHNICAL DATA	
ART.	Lunghezza / Length
	mm
E93034	145



FORBICE PER ELETTRICISTA ELECTRICIANS SCISSORS

In acciaio inox, manici in PVC, lame zigrinate.

Made of stainless steel, PVC handles, milled blades.

DATI TECNICI / TECHNICAL DATA	
ART.	Lunghezza / Length
	mm
E93049	145



UTENSILI DA TAGLIO CUTTING TOOLS

FORBICE MULTIUSO MULTI-PURPOSE SCISSORS

In acciaio inox, manici isolati in TPR, lame ziggrinate.

Made of stainless steel, insulated TPR handles, milled blades.

DATI TECNICI / TECHNICAL DATA	
ART.	Lunghezza / Length
	mm
E93035	175



CUTTER COMPLETO DI 3 LAME UTILITY KNIFE WITH 3 BLADES

Lama in acciaio SK2, made in Japan. Impugnatura anatomica. Vite di bloccaggio. Disponibile in rosso e blu.

SK2 steel blade made in Japan. Ergonomic grip. Locking screw. Available in red and blue.

DATI TECNICI / TECHNICAL DATA	
ART.	Larghezza lama Blade width
	mm
E15332	25

LAME DI RICAMBIO / SPARE BLADES	
ART.	Descrizione Description
E15342	blister 10 lame blister 10 blades



Espositore 24 pezzi
24-piece display

CUTTER COMPLETO DI 3 LAME UTILITY KNIFE WITH 3 BLADES

Lama in acciaio SK2, made in Japan. Impugnatura anatomica. Vite di bloccaggio. Disponibile in rosso e blu.

SK2 steel blade made in Japan. Ergonomic grip. Locking screw. Available in red and blue.

DATI TECNICI / TECHNICAL DATA	
ART.	Larghezza lama Blade width
	mm
E15331	18

LAME DI RICAMBIO / SPARE BLADES	
ART.	Descrizione Description
E15341	blister 10 lame blister 10 blades



Espositore 24 pezzi
24-piece display

COLTELLO SERRAMANICO FOLDING KNIFE

In acciaio inox.

Made of stainless steel.

DATI TECNICI / TECHNICAL DATA			
ART.	Lunghezza lama Blade length	Lunghezza aperto Open length	Lunghezza chiuso Closed length
	mm	cm	cm
E15335	80	19,5	10,5



COLTELLO SERRAMANICO FOLDING KNIFE

In acciaio inox.

Made of stainless steel.

DATI TECNICI / TECHNICAL DATA			
ART.	Lunghezza lama Blade length	Lunghezza aperto Open length	Lunghezza chiuso Closed length
	mm	cm	cm
E15336	80	19,5	10,5



UTENSILI DA TAGLIO CUTTING TOOLS

SEGHETTO MANUALE BOW SAW

Lama in acciaio HSSE.
Corpo in alluminio con una lama in dotazione.

HSSE steel blade aluminum frame one blade included.

DATI TECNICI / TECHNICAL DATA	
ART.	Lunghezza lama Blade length
	mm
E87040	300

LAME DI RICAMBIO / SPARE BLADES	
ART.	Descrizione Description
08128	10 lame 10 blades



SEGHETTO MANUALE BOW SAW

Lama in acciaio HSSE.
Corpo in alluminio con una lama in dotazione.

HSSE steel blade aluminum frame one blade included.

DATI TECNICI / TECHNICAL DATA	
ART.	Lunghezza lama Blade length
	mm
E87054	300

LAME DI RICAMBIO / SPARE BLADES	
ART.	Descrizione Description
08128	10 lame 10 blades



SEGHETTO MANUALE 5 IN 1 5-IN-1 BOW SAW

Corpo in ABS.
5 lame in dotazione.

ABS frame.
5 blades included.

DATI TECNICI / TECHNICAL DATA	
ART.	Lunghezza lama Blade length
	mm
E87047	150



SET 5 LIME / 5-PIECE FILE SET

Lama in acciaio HSSE.
Impugnatura in bicomponente.

HSSE steel blade.
Bi-material handle.

DATI TECNICI / TECHNICAL DATA		
ART.	E05149	E02019
Confezione / Packaging	termoretraibile shrink film	valigetta ABS ABS case



MARTELLI HAMMERS

MAZZUOLE IN PLASTICA / PLASTIC MALLETS

DATI TECNICI / TECHNICAL DATA

ART.	Misura / Size
	mm
E20186	28
E20187	35
E20188	45
E20189	60



MAZZUOLE IN POLIURETANO / POLYURETHANE MALLETS

DATI TECNICI / TECHNICAL DATA

ART.	Misura / Size
	mm
E20181	28
E20182	35
E20183	42
E20184	60



MAZZUOLE IN GOMMA / RUBBER MALLETS

DATI TECNICI / TECHNICAL DATA

ART.	Misura / Size
	mm
E20171	40
E20172	50
E20173	60
E20174	70



MAZZETTE DA MURATORE / CLUB HAMMERS

Bloccaggio di sicurezza e manico in legno sbiancato. DIN 6475.

Bleached wooden handle. Handle securely fixed to the head. DIN 6475.

DATI TECNICI / TECHNICAL DATA

ART.	Peso / Weight
	gr
E20261	800
E20262	1000
E20263	1250
E20264	1500



MAZZETTE DA MURATORE / CLUB HAMMERS

Manico sintetico ed impugnatura anti-scivolo. DIN 6475.

Synthetic handle with non-slip grip. DIN 6475.

DATI TECNICI / TECHNICAL DATA

ART.	Peso / Weight
	gr
E20271	800
E20272	1000
E20273	1250



MARTELLI E ASCE HAMMERS AND AXES

MARTELLI TIPO TEDESCO / MACHINISTS' HAMMERS

DATI TECNICI / TECHNICAL DATA	
ART.	Peso / Weight gr
E20230	100
E20231	200
E20232	300
E20233	400

DATI TECNICI / TECHNICAL DATA	
ART.	Peso / Weight gr
E20234	500
E20236	800
E20237	1000
E20238	1500



MARTELLI TIPO TEDESCO / MACHINISTS' HAMMERS

Manico di legno sbiancato e sagomato. Bloccaggio di sicurezza antisfilamento. DIN 1041.

Bleached and ergonomic wooden handle. Handle securely fixed to the head. DIN 1041.

DATI TECNICI / TECHNICAL DATA	
ART.	Peso / Weight gr
E20239	2000



MARTELLI TIPO TEDESCO / MACHINISTS' HAMMERS

Manico sintetico ed impugnatura antiscivolo. DIN 1041

Synthetic handle with non-slip grip. DIN 1041.

DATI TECNICI / TECHNICAL DATA	
ART.	Peso / Weight gr
E20251	200
E20252	300
E20253	400
E20254	500



MAZZE A COPPIA / SLEDGE HAMMERS

Manico sintetico ed impugnatura antiscivolo. DIN 6475.

Synthetic handle with non-slip grip. DIN 6475.

DATI TECNICI / TECHNICAL DATA	
ART.	Peso / Weight gr
E20276	3000
E20277	4000
E20278	5000



PICCOZZINO MULTIUSO / MULTIPURPOSE SMALL AXE

Manico acciaio / plastica.

Steel / plastic handle.

DATI TECNICI / TECHNICAL DATA	
ART.	Peso / Weight gr
E20280	600



ASCE / AXES

Manico sintetico ed impugnatura antiscivolo. DIN 5131.

Synthetic handle with non-slip grip. DIN 5131.

DATI TECNICI / TECHNICAL DATA	
ART.	Peso / Weight gr
E20281	600
E20282	800



SCURE DA SPACCO / SPLITTING AXE

Manico sintetico ed impugnatura antiscivolo.

Synthetic handle with non-slip grip.

DATI TECNICI / TECHNICAL DATA	
ART.	Peso / Weight gr
E20283	3000



RIVETTATRICI RIVETERS

RIVETTATRICE MANUALE / HAND RIVETER

In alluminio con impugnatura anatomica in PVC e parti meccaniche in acciaio speciale.

Made of aluminum with ergonomic PVC handle and mechanical parts made of special steel.

DATI TECNICI / TECHNICAL DATA	
ART.	Rivetti / Rivets mm
E93015	2,4 - 3,2 - 4 - 4,8

Confezione: blister / Packaging: blister



RIVETTATRICE TESTA GIREVOLE / SWIVEL-HEAD RIVETER

In alluminio con impugnatura anatomica in PVC e parti meccaniche in acciaio speciale. Testa girevole a 360°.

Made of aluminum with ergonomic PVC handle and mechanical parts made of special steel. Head swivels at 360°.

DATI TECNICI / TECHNICAL DATA	
ART.	Rivetti / Rivets mm
E93016	2,4 - 3,2 - 4 - 4,8

Confezione: blister / Packaging: blister

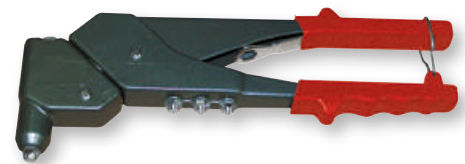

RIVETTATRICE MANUALE / HAND RIVETER

In alluminio con impugnatura anatomica in PVC e parti meccaniche in acciaio speciale. Consente una riduzione dello sforzo del 30%.

Made of aluminum with ergonomic PVC handle and mechanical parts made of special steel. 30% less effort when working.

DATI TECNICI / TECHNICAL DATA	
ART.	Rivetti / Rivets mm
E93039	3,2 - 4 - 4,8 - 6,4

Confezione: scatola / Packaging: box



PINZA FUSTELLATRICE / PUNCH PLIERS

In acciaio stampato, con 6 fustelle.

Made of pressed steel, with 6 punches.

DATI TECNICI / TECHNICAL DATA	
ART.	Fustelle / Punches mm
04084	2 - 2,5 - 3 - 3,5 - 4 - 5

Confezione: scatola / Packaging: box



AGGRAFFATRICI TACKERS

AGGRAFFATRICE MANUALE / HAND TACKER

Corpo in alluminio+ABS.
Compatibile con: Arrow - Esco - KWB
Novus - Rapid - Rocafix - Stanley.

Made of aluminum and ABS.
Suitable with: Arrow - Esco - KWB
Novus - Rapid - Rocafix - Stanley.

ART.
E87038

Confezione: doppio blister / Packaging: double blister

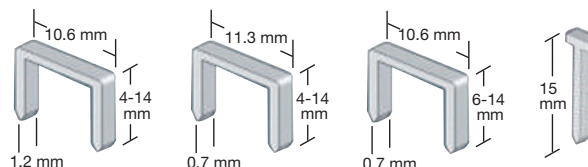

AGGRAFFATRICE MANUALE / HAND TACKER

Corpo in alluminio.
Compatibile con: Arrow - Esco - KWB
- Novus - Rapid - Rocafix - Stanley.

Made of aluminum.
Suitable with: Arrow - Esco - KWB -
Novus - Rapid - Rocafix - Stanley.

ART.
E87037

Confezione: doppio blister / Packaging: double blister

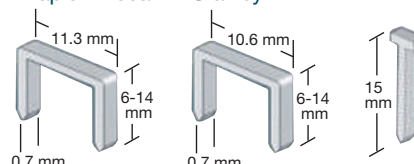

AGGRAFFATRICI TACKERS

AGGRAFFATRICE A BATTERE / HAMMER TACKER

Corpo in alluminio.
Compatibile con: Arrow - Esco - KWB
Novus - Rapid - Rocafix - Stanley.

Made of aluminum.
Suitable with: Arrow - Esco - KWB
Novus - Rapid - Rocafix - Stanley.

ART.
E87039

Confezione: doppio blister / Packaging: double blister

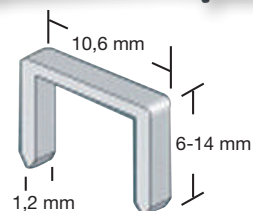

PUNTI PER AGGRAFFATRICI / TACKER STAPLES

DATI TECNICI / TECHNICAL DATA	
ART.	Misura / Size
	mm
E87033	6
E87050	8
E87051	10
E87052	12
E87053	14

Confezione da 500 pezzi / 500-piece pack

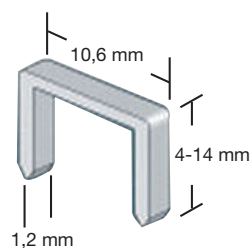

CHIODI PER AGGRAFFATRICI / TACKER NAILS

DATI TECNICI / TECHNICAL DATA	
ART.	Misura / Size
	mm
E87034	10
E87035	12

Confezione da 1.000 pezzi / 1.000-piece pack

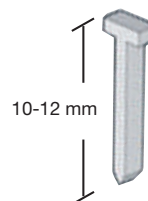

PISTOLE PER SILICONE CAULK GUNS

PISTOLA PER SILICONE / CAULK GUN

In alluminio per uso professionale.
Con funzione antigoccia. Molla guida cartuccia.

Made of aluminum for professional use. Dripless. Cartridge spring.

ART.
E93008



PISTOLA PER SILICONE / CAULK GUN

In alluminio per uso professionale.

Made of aluminum for professional use.

ART.
E93012



PISTOLA PER SILICONE / CAULK GUN

In alluminio con tubo in policarbonato indeformabile. Per uso professionale.

Made of aluminium with polycarbonate rod. For professional use.

ART.
E93011



PISTOLA PER TASSELLI CHIMICI CHEMICAL ANCHOR GUN

In alluminio per uso professionale.
Per cartucce 380 ml.

Made of aluminum for professional use.
Cartridge 380 ml.

ART.
E93010



CARRELLI E BANCHI DA LAVORO CARTS AND WORKBENCHES

CARRELLO DA OFFICINA CON 7 CASSETTI WORKSHOP CART WITH 7 DRAWERS

Guide su cuscinetto a estrazione totale con richiamo soft. Ruote in PP con bloccaggio su due ruote. Verniciatura ad alta resistenza anti-graffio. Lamiera doppio spessore con profilo arrotondato. Tappetino in gomma antistatico e antiscivolo. Chiusura a chiave.

Ball bearing rails for smooth sliding drawers. PP castors, two with brake. Powder coat finish. Double thick metal sheet with rounded profile. Nonslip, antistatic mat. Locking with key.

DATI TECNICI / TECHNICAL DATA

ART.	E09010	E09013
Tipo / Type	vuoto empty	con 138 utensili with 138 tools
Peso netto / Net weight	kg	69
Altezza / Height	mm	995
Larghezza / Width	mm	680
Profondità / Depth	mm	458
Dimensioni ruote Castor dimensions	mm	125x50
Portata cassetti Drawer capacity	kg	45



ART. E09013

COMPOSIZIONE / CONTENT

		Pag. / Page
E05940	Set chiavi a bussola / Socket set	9
E05941	Set chiavi a bussola / Socket set	9
E05942	Set bussole e inserti / Socket and bit set	10
E05149	Set 5 lime / 5-piece file set	51
E01000	Set chiavi a T esagonali / T-handle hex key set	20
E07016	Set chiavi combinate / Combination wrench set	15
E07246	Set giraviti Torx / Torx screwdriver set	36
E05151	Set pinze per anelli / Circlip pliers set	42
E93044	Set 3 pinze / 3-piece pliers set	42



E05940



E05941



E05942



E05149



E01000



E07016



E07246



E05151



E93044

CARRELLI E BANCHI DA LAVORO

CARTS AND WORKBENCHES

CARRELLO DA OFFICINA

WORKSHOP CART

DATI TECNICI / TECHNICAL DATA			
ART.		E08001	
Peso netto / Net weight	kg	28	
Altezza / Height	mm	780	
Larghezza / Width	mm	720	
Profondità / Depth	mm	360	



CARRELLO DA OFFICINA CON 2 CASSETTI

WORKSHOP CART WITH 2 DRAWERS

Con cassetti antiribaltamento e chiusura a chiave.

With anti-tipping drawers. It locks with key.

DATI TECNICI / TECHNICAL DATA			
ART.		E08000	
Peso netto / Net weight	kg	28	
Altezza / Height	mm	830	
Larghezza / Width	mm	705	
Profondità / Depth	mm	370	
Dimensioni ruote Castor dimensions	mm	100	
Dimensioni cassetti Drawer dimensions	mm	580x320x600	



BANCO DA LAVORO CON 3 CASSETTI

WORKBENCH WITH 3 DRAWERS

Con 2 armadietti portautensili e chiusura a chiave.

With 2 cabinets. It locks with key.

DATI TECNICI / TECHNICAL DATA			
ART.		E09007	
Peso netto / Net weight	kg	86	
Altezza / Height	mm	1500	
Larghezza / Width	mm	1500	
Profondità / Depth	mm	700	
Spessore lamiera Sheet thickness	mm	2	
Dimensioni 1 cassetto Dimensions of 1 drawers	mm	572x270x65	
Dimensioni 2 cassetti Dimensions of 2 drawers	mm	572x270x41	



BANCO DA LAVORO

WORKBENCH

Con ripiano in legno.

With wooden worktop.

DATI TECNICI / TECHNICAL DATA			
ART.		E09017	
Peso netto / Net weight	kg	42,5	
Altezza / Height	mm	865	
Larghezza / Width	mm	1372	
Profondità / Depth	mm	508	
Dimensioni mensola Shelf dimensions	mm	450x440	



VALIGIE PORTAUTENSILI TOOL CASES

CASSETTIERA COMPLETA DI 104 UTENSILI CASE WITH 104 TOOLS

Utensili in Cromo Vanadio e acciaio S2 con finitura satinata lucida, cassettera in metallo e plastica. Cassetti montati su guide a cuscinetti, chiusura a cerniera.

Tools made of Chrome Vanadium and S2 steel with matte bright finish, case made of metal and plastic. Drawers with ball bearing rails, security latches.

DATI TECNICI / TECHNICAL DATA

ART.

E09065

COMPOSIZIONE:

1° CASSETTO - UTENSILI in CROMO VANADIO

- 2 cricchetti 72 denti
- 13 bussole 1/2" 10 - 13 - 14 - 15 - 17 - 18 - 19 - 20 - 22 - 24 - 27 - 30 - 32 mm
- 13 bussole 1/4" 4 - 4,5 - 5 - 5,5 - 6 - 7 - 8 - 9 - 10 - 11 - 12 - 13 - 14 mm
- 2 bussole candela 16 - 21 mm
- 2 prolunghe 1/2" 125 - 250 mm
- 1 prolunga 1/4" 100 mm
- 2 snodi universali 1/2" - 1/4"
- 2 chiavi a T 1/2" - 1/4"
- 1 prolunga flessibile 150 mm

2° CASSETTO - UTENSILI in CROMO VANADIO

- 12 chiavi combinate 6 - 7 - 8 - 9 - 10 - 11 - 12 - 13 - 14 - 17 - 19 - 22 mm
- 9 chiavi esagonali 1,5 - 2 - 2,5 - 3 - 4 - 5 - 6 - 8 - 10 mm

3° CASSETTO - UTENSILI in ACCIAIO S2

- 8 inserti Phillips PH1 - 1 - 1 - 2 - 2 - 2 - 2 - 3
- 7 inserti Pozidriv PZ1 - 1 - 1 - 2 - 2 - 2 - 3
- 5 inserti a taglio 3 - 4 - 4,5 - 5 - 6 mm
- 6 inserti esagonali 3 - 4 - 5 - 5 - 6 - 6 mm
- 7 inserti Torx T10 - 15 - 20 - 25 - 27 - 30 - 40
- 1 adattatore bussola 1/4"
- 1 giravite portainseri 1/4"
- 2 giraviti a taglio 5,5x125 - 6,5x150 mm
- 2 giraviti Phillips PH1x80 - PH2x150 mm

CONTENT:

1° DRAWER - TOOLS made of CHROME VANADIUM

- 2 ratchets 72 teeth
- 13 sockets 1/2" 10 - 13 - 14 - 15 - 17 - 18 - 19 - 20 - 22 - 24 - 27 - 30 - 32 mm
- 13 sockets 1/4" 4 - 4,5 - 5 - 5,5 - 6 - 7 - 8 - 9 - 10 - 11 - 12 - 13 - 14 mm
- 2 glow plug sockets 16 - 21 mm
- 2 extensions 1/2" 125 - 250 mm
- 1 extension 1/4" 100 mm
- 2 universal joints 1/2" - 1/4"
- 2 T-wrenches 1/2" - 1/4"
- 1 flexible extension 150 mm

2° DRAWER - TOOLS made of CHROME VANADIUM

- 12 combination wrenches 6 - 7 - 8 - 9 - 10 - 11 - 12 - 13 - 14 - 17 - 19 - 22 mm
- 9 hex wrenches 1,5 - 2 - 2,5 - 3 - 4 - 5 - 6 - 8 - 10 mm

3° DRAWER - TOOLS made of S2 STEEL

- 8 Phillips bits PH1 - 1 - 1 - 2 - 2 - 2 - 2 - 3
- 7 Pozidriv bits PZ1 - 1 - 1 - 2 - 2 - 2 - 3
- 5 slotted bits 3 - 4 - 4,5 - 5 - 6 mm
- 6 hex bits 3 - 4 - 5 - 5 - 6 - 6 mm
- 7 Torx bits T10 - 15 - 20 - 25 - 27 - 30 - 40
- 1 socket adaptor 1/4"
- 1 bit holder screwdriver 1/4"
- 2 slotted screwdrivers 5,5x125 - 6,5x150 mm
- 2 Phillips screwdrivers PH1x80 - PH2x150 mm



VALIGIE PORTAUTENSILI TOOL CASES

VALIGIA COMPLETA DI 111 UTENSILI CASE WITH 111 TOOLS

Valigia in alluminio. Chiusura a chiave.
Dimensioni valigia 460x330x155 mm

Aluminum case. It locks with key.
Case dimensions 460x330x155 mm

DATI TECNICI / TECHNICAL DATA

ART. E09067

COMPOSIZIONE:

1° PANNELLO - UTENSILI in CROMO VANADIO

- 2 cricchetti 72 denti
- 13 bussole 1/2" 10 - 13 - 14 - 16 -17 - 18 - 19 - 20 - 22 - 24 - 27 - 30 - 32 mm
- 13 bussole 1/4" 4 - 4,5 - 5 - 5,5 - 6 - 7 - 8 - 9 - 10 - 11 - 12 - 13 - 14 mm
- 2 bussole candela 16 - 21 mm
- 2 prolunghe 1/2" 125 - 250 mm
- 2 prolunghe 1/4" 50 - 100 mm
- 2 snodi universali 1/2" - 1/4"
- 2 chiavi a T 1/2" - 1/4"
- 1 giravite portainserti 1/4"
- 1 adattatore 1/4"
- 1 martello 300 gr
- 1 flessometro 5 m
- 32 inserti 1/4"

2° PANNELLO - UTENSILI in CROMO VANADIO

- 1 tenaglia cementista 220 mm
- 1 pinza universale 180 mm
- 1 pinza poligrip 240 mm
- 1 pinza becchi mezzi tondi 160 mm
- 1 tronchese diagonale 150 mm
- 2 giraviti Phillips PH1x80 - PH2x150 mm
- 2 giraviti a taglio 5,5x125 - 6,5x150 mm

3° PANNELLO - UTENSILI in CROMO VANADIO

- 1 livella in alluminio
- 8 chiavi esagonali 2 - 2,5 - 3 - 4 - 5 - 6 - 8 - 10 mm
- 1 forbice per elettricista 145 mm
- 1 torcia a LED
- 1 mini seghetto 150 mm con 3 lame di ricambio

4° PANNELLO - UTENSILI in CROMO VANADIO

- 1 calibro 150 mm
- 1 lima 200 mm
- 8 chiavi combinate 8 - 9 - 10 - 11 - 13 - 14 - 17 - 19 mm
- 1 cercafase 110-500 V
- 1 cutter lama 18 mm

CONTENT:

1° PANEL - TOOLS made of CHROME VANADIUM

- 2 ratchets 72 teeth
- 13 sockets 1/2" 10 - 13 - 14 - 16 -17 - 18 - 19 - 20 - 22 - 24 - 27 - 30 - 32 mm
- 13 sockets 1/4" 4 - 4,5 - 5 - 5,5 - 6 - 7 - 8 - 9 - 10 - 11 - 12 - 13 - 14 mm
- 2 glow plug sockets 16 - 21 mm
- 2 extensions 1/2" 125 - 250 mm
- 2 extensions 1/4" 50 - 100 mm
- 2 universal joints 1/2" - 1/4"
- 2 T-wrenches 1/2" - 1/4"
- 1 bit holder screwdriver 1/4"
- 1 adaptor 1/4"
- 1 hammer 300 gr
- 1 measuring tape 5 m
- 32 bits 1/4"

2° PANEL - TOOLS made of CHROME VANADIUM

- 1 nipper 220 mm
- 1 universal pliers 180 mm
- 1 poligrip pliers 240 mm
- 1 half-round nose pliers 160 mm
- 1 diagonal clipper 150 mm
- 2 Phillips screwdrivers PH1x80 - PH2x150 mm
- 2 slotted screwdrivers 5,5x125 - 6,5x150 mm

3° PANEL - TOOLS made of CHROME VANADIUM

- 1 aluminum level
- 8 hex wrenches 2 - 2,5 - 3 - 4 - 5 - 6 - 8 - 10 mm
- 1 electricians scissor 145 mm
- 1 flashlight LED
- 1 mini saw 150 mm with 3 spare blades

4° PANEL - TOOLS made of CHROME VANADIUM

- 1 caliper 150 mm
- 1 file 200 mm
- 8 combination wrenches 8 - 9 - 10 - 11 - 13 - 14 - 17 - 19 mm
- 1 test light 110-500 V
- 1 utility knife blade 18 mm



VALIGIE PORTAUTENSILI TOOL CASES

VALIGIA COMPLETA DI 81 UTENSILI CASE WITH 81 TOOLS

Utensili in Cromo Vanadio con finitura satinata lucida.

Tools made of Chrome Vanadium with matte bright finish.

DATI TECNICI / TECHNICAL DATA

ART. E09066

COMPOSIZIONE:

- 2 cricchetti 72 denti
- 12 bussole 1/2" 15 - 16 - 17 - 18 - 19 - 20 - 21 - 22 - 24 - 27 - 30 - 32 mm
- 13 bussole 1/4" 4 - 4,5 - 5 - 5,5 - 6 - 7 - 8 - 9 - 10 - 11 - 12 - 13 - 14 mm
- 2 bussole lunghe 1/2" 17 - 19 mm
- 3 bussole lunghe 1/4" 8 - 10 - 13 mm
- 1 prolunga flessibile 150 mm
- 2 prolunghe 1/2" 125 - 250 mm
- 2 prolunghe 1/4" 50 - 100 mm
- 2 snodi universali 1/2" - 1/4"
- 2 chiavi a T 1/2" - 1/4"
- 4 inserti esagonali 1/4" 3 - 4 - 5 - 6 mm
- 3 inserti Phillips 1/4" PH1 - 2 - 3
- 3 inserti Pozidriv 1/4" PZ1 - 2 - 3
- 4 inserti a taglio 1/4" 3 - 4 - 5 - 6 mm
- 5 inserti Torx 1/4" T15 - 20 - 25 - 27 - 30
- 4 inserti esagonali 5/16" 8 - 10 - 12 - 14 mm
- 2 inserti Phillips 5/16" PH3 - 4
- 2 inserti Pozidriv 5/16" PZ3 - 4
- 3 inserti a taglio 5/16" 8 - 10 - 12 mm
- 4 inserti Torx T40 - 45 - 50 - 55
- 1 giravite portainseri 1/4"
- 1 adattatore per bussole 1/4"
- 3 chiavi esagonali 1,5 - 2 - 2,5 mm
- 1 adattatore per inserti 5/16"

CONTENT:

- 2 ratchets 72 teeth
- 12 sockets 1/2" 15 - 16 - 17 - 18 - 19 - 20 - 21 - 22 - 24 - 27 - 30 - 32 mm
- 13 sockets 1/4" 4 - 4,5 - 5 - 5,5 - 6 - 7 - 8 - 9 - 10 - 11 - 12 - 13 - 14 mm
- 2 long sockets 1/2" 17 - 19 mm
- 3 long sockets 1/4" 8 - 10 - 13 mm
- 1 flexible extension 150 mm
- 2 extensions 1/2" 125 - 250 mm
- 2 extensions 1/4" 50 - 100 mm
- 2 universal joints 1/2" - 1/4"
- 2 T-wrenches 1/2" - 1/4"
- 4 hex bits 1/4" 3 - 4 - 5 - 6 mm
- 3 Phillips bits 1/4" PH1 - 2 - 3
- 3 Pozidriv bits 1/4" PZ1 - 2 - 3
- 4 slotted bits 1/4" 3 - 4 - 5 - 6 mm
- 5 Torx bits 1/4" T15 - 20 - 25 - 27 - 30
- 4 hex bits 5/16" 8 - 10 - 12 - 14 mm
- 2 Phillips bits 5/16" PH3 - 4
- 2 Pozidriv bits 5/16" PZ3 - 4
- 3 slotted bits 5/16" 8 - 10 - 12 mm
- 4 Torx bits T40 - 45 - 50 - 55
- 1 bit holder screwdriver 1/4"
- 1 socket adaptor 1/4"
- 3 hex keys 1,5 - 2 - 2,5 mm
- 1 bit adaptor 5/16"



VALIGIE PORTAUTENSILI VUOTE EMPTY TOOL CASES

CASSETTA VUOTA PER TERMOFORMATI EMPTY CASE FOR THERMOFORMED TRAYS

Materiale termoplastico.

Made of thermoplastic material.

DATI TECNICI / TECHNICAL DATA	
ART.	Dimensioni / Dimensions mm
E02999	420x270x60



VALIGIA IN ABS CON TROLLEY ABS TOOL CASE WITH WHEELS

In ABS con fondo in materiale plastico. Pannelli portautensili con elastici, chiusura a combinazione.

Made of ABS with plastic bottom. Tool boards with elasticated retaining loops, combination lock.

DATI TECNICI / TECHNICAL DATA	
ART.	Dimensioni / Dimensions mm
30325	482x235x373



VALIGIA PORTAUTENSILI TOOL CASE

In ABS. Pannelli portautensili con elastici, chiusura a chiave.

Made of ABS. Tool boards with elasticated retaining loops, key lock.

DATI TECNICI / TECHNICAL DATA	
ART.	Dimensioni / Dimensions mm
E50007	460x165x330



VALIGIA PORTAUTENSILI TOOL CASE

In ABS. Pannelli portautensili con elastici, chiusura a chiave.

Made of ABS. Tool boards with elasticated retaining loops, key lock.

DATI TECNICI / TECHNICAL DATA	
ART.	Dimensioni / Dimensions mm
E50002	460x180x360



BAULETTO IN ALLUMINIO CON CASSETTO TOOL CASE WITH DRAWER

In alluminio. Chiusura a chiave.

Made of aluminum. Key lock.

DATI TECNICI / TECHNICAL DATA	
ART.	Dimensioni / Dimensions mm
30133	430x300x223



VALIGIE PORTAUTENSILI VUOTE EMPTY TOOL CASES

BORSE PORTAUTENSILI TOOL BAGS

In cuoio. Pannelli portautensili con elastici.

Made of leather. Boards with elasticated retaining loops.

DATI TECNICI / TECHNICAL DATA	
ART.	Dimensioni / Dimensions mm
30306	400x120x250
30305	400x180x180



13

GILET PORTAUTENSILI CON TASCHE TOOL VEST WITH POCKETS

In poliestere.

Made of polyester.

ART.
E60004



GILET PORTAUTENSILI TOOL VEST

In poliestere.

Made of polyester.

ART.
E60000



ATTREZZI MAGNETICI E TORCE MAGNETIC TOOLS AND FLASHLIGHTS

CALAMITA TELESCOPICA SNODATA FLEXIBLE TELESCOPIC MAGNET

In acciaio zincato. Con testa snodata. Punteruolo ideale per lavori di precisione, pulitura e regolazione di lavaparebrezza.

Made of galvanized steel. Flexible head. Ideal for precision work, for cleaning and adjusting windshield washing nozzle.

DATI TECNICI / TECHNICAL DATA	
ART.	E07022
Estensione / Extension	cm fino a 60 / up to 60
Capacità magnete Magnet capacity	kg 1

Confezione: blister / Packaging: blister



ARTIGLIO PRENSILE MAGNETICO CON LUCE FLEXIBLE MAGNETIC CLAW WITH LIGHT

In acciaio. Impugnatura in bicomponente.

Made of steel. Bi-material handle.

DATI TECNICI / TECHNICAL DATA	
ART.	E07019
Lunghezza / Length	mm 600
Capacità magnete Magnet capacity	kg 1

Confezione: blister / Packaging: blister



ATTREZZI MAGNETICI E TORCE MAGNETIC TOOLS AND FLASHLIGHTS

VASCHETTA MAGNETICA MAGNETIC TRAY

In gomma antigraffio.
Barra portautensili magnetica.

Made of scratch resistant rubber.
Magnetic tool bar.

DATI TECNICI / TECHNICAL DATA

ART.	E06024	
Misura / Size	cm	24x25

Confezione: scatola / Packaging: box



LENTE DI INGRANDIMENTO MAGNIFYING GLASS

Base magnetica. Alimentazione con rete fissa e batteria. Supporto magnetico. Luce 14 LED antiriflesso. Morsetto di bloccaggio in dotazione. Ideale per lavori di precisione.

Magnetic base. Power supply: cord and batteries. Magnetic support. Anti-glare 14 LED. Supplied with clamp. Ideal for precision working.

DATI TECNICI / TECHNICAL DATA

ART.	E02139	
Ø lente / Lens Ø	mm	100
Tubo flessibile / Flexible arm	mm	250

Confezione: scatola / Packaging: box



LUCE LED FLESSIBILE FLEXIBLE LED LAMPS

Base magnetica. Alimentazione a batteria. Supporto magnetico. Luce a 3 LED. Ideale per macchine utensili.

Magnetic base. Power supply: batteries. Magnetic support. 3 LED. Supplied with clamp. Ideal for machine tools.

DATI TECNICI / TECHNICAL DATA

ART.	E02136	
Lunghezza totale / Overall length	mm	360
Tubo flessibile / Flexible arm	mm	250
Batterie LR44 / Batteries LR44	N°	3 incluse / 3 included

Confezione: blister / Packaging: blister



TORCIA LED LED FLASHLIGHT

Cinturina in dotazione.

Wrist strap included.

DATI TECNICI / TECHNICAL DATA

ART.	E02142	
Lunghezza / Length	mm	135
Lampada LED / LED lamp	W	3
Pile / Batteries	N°	3xAAA non include / 3xAAA not included



